

 **IO-Link**



Operating instructions
30.30.01.00762

EN
SCPSi-2
Eco-Nozzle Technology

CONTENTS

| | | |
|----------|---|-------------|
| 1 | Safety Instructions | 1-5 |
| | Important symbols | 1-5 |
| | General safety instructions | 1-5 |
| | Intended use | 1-6 |
| | Installation and operation | 1-7 |
| 2 | Product Overview | 2-8 |
| | General description of functions..... | 2-8 |
| | Vacuum generation (picking up the workpiece) | 2-8 |
| | Blow-off (depositing the workpiece) | 2-9 |
| | IO-Link..... | 2-9 |
| | Versions | 2-10 |
| | Ejector version PNP or NPN..... | 2-10 |
| | Electrical connection | 2-10 |
| | Ejector design | 2-11 |
| | Operating and display elements | 2-12 |
| 3 | Description of Functions..... | 3-14 |
| | Operating modes..... | 3-14 |
| | Control concept for NO ejectors..... | 3-16 |
| | Control concept for NC ejectors..... | 3-16 |
| | General functions..... | 3-17 |
| | Manual mode | 3-17 |
| | Set-up mode | 3-18 |
| | Monitoring the system vacuum | 3-18 |
| | Zero-point adjustment of the sensor (calibration) | 3-18 |
| | Control function..... | 3-19 |
| | Deactivating the control shutoff function | 3-19 |
| | Blow-off modes | 3-20 |
| | Signal output..... | 3-21 |
| | Selecting the vacuum unit | 3-21 |
| | Switch-off delay of the H2 component check signal | 3-22 |
| | ECO-Mode..... | 3-22 |
| | PIN for write protection | 3-23 |
| | Write protection with Device Access Locks | 3-23 |
| | Reset to factory settings..... | 3-24 |
| | Counter..... | 3-24 |
| | Voltage monitoring | 3-25 |
| | Evaluating the inlet pressure | 3-25 |
| | Setting the blow-off volume flow | 3-26 |
| | Production setup-profiles..... | 3-26 |
| | Condition Monitoring [CM] | 3-27 |
| | Monitoring the valve switching frequency..... | 3-27 |
| | Monitoring the control threshold..... | 3-27 |
| | Monitoring the evacuation time..... | 3-28 |
| | Monitoring leakage..... | 3-28 |
| | Monitoring the dynamic pressure..... | 3-28 |
| | Evaluating the leakage level | 3-29 |
| | Measurement of the evacuation time t_0 | 3-29 |
| | Measurement of the evacuation time t_1 | 3-29 |

| | | |
|----------|---|-------------|
| | Autoset | 3-29 |
| | Energy monitoring [EM]..... | 3-30 |
| | Percentual air consumption measurement | 3-30 |
| | Absolute air consumption measurement | 3-30 |
| | Energy consumption measurement | 3-30 |
| | Predictive Maintenance [PM] | 3-31 |
| | Measurement of the leakage | 3-31 |
| | Measurement of the dynamic pressure | 3-31 |
| | Quality assessment | 3-31 |
| | Performance calculation | 3-31 |
| | Diagnostic buffer..... | 3-32 |
| | EPC data buffer | 3-32 |
| 4 | Operating and Menu Concepts..... | 4-33 |
| | Vacuum display..... | 4-33 |
| | Individual functions | 4-33 |
| | Supply voltage | 4-33 |
| | Operating mode display..... | 4-34 |
| | Error display..... | 4-34 |
| | Main menu..... | 4-35 |
| | Setting the parameters in the main menu | 4-36 |
| | Zero-point adjustment (calibration) | 4-36 |
| | Configuration menu | 4-37 |
| | Setting the parameters in the configuration menu | 4-39 |
| | Entering the PIN..... | 4-39 |
| | Executing the “reset to factory settings” function..... | 4-39 |
| | System menu | 4-40 |
| | Viewing data in the system menu | 4-40 |
| | Viewing the counters | 4-40 |
| | Software version | 4-41 |
| | Serial number..... | 4-41 |
| | Article number..... | 4-41 |
| 5 | Operating Mode | 5-42 |
| | SIO operating mode | 5-42 |
| | Overview..... | 5-42 |
| | Mounting..... | 5-43 |
| | Pneumatic connection | 5-43 |
| | Electrical connection | 5-44 |
| | Pin assignment of the connection plug..... | 5-45 |
| | Projektieren..... | 5-46 |
| | Start of operations..... | 5-46 |
| | Warnings and errors..... | 5-47 |
| | IO-Link mode | 5-48 |
| | Overview..... | 5-48 |
| | Mounting..... | 5-49 |
| | Pneumatic connection | 5-49 |
| | Electrical connection | 5-50 |
| | Pin assignment of the connection plug..... | 5-51 |
| | Project planning | 5-51 |
| | Process data | 5-53 |
| | Parameter data | 5-54 |
| | Configuration server | 5-54 |
| | Start of operations..... | 5-55 |
| | System status light | 5-60 |
| | Warnings and errors..... | 5-60 |

| | | |
|----------|---|-------------|
| | EPC-Values in the Process data..... | 5-61 |
| 6 | Maintenance | 6-62 |
| | General maintenance..... | 6-62 |
| | Exterior soiling | 6-62 |
| | Silencer..... | 6-62 |
| | press-in Screens | 6-62 |
| | Warranty, spare parts and wearing parts..... | 6-62 |
| | Spare and wearing parts | 6-63 |
| | Troubleshooting..... | 6-63 |
| | Accessories..... | 6-63 |
| 7 | Technical Data | 7-64 |
| | Electrical parameters..... | 7-64 |
| | Display parameters..... | 7-65 |
| | Mechanical data | 7-65 |
| | General parameters | 7-65 |
| | Materials used..... | 7-66 |
| | Mechanical parameters | 7-66 |
| | Dimensions | 7-67 |
| | Pneumatic circuit diagrams..... | 7-68 |
| | Overview of display symbols | 7-69 |
| | Factory settings | 7-71 |
| 8 | Conformity Declaration | 8-72 |

1 SAFETY INSTRUCTIONS

IMPORTANT SYMBOLS



This symbol indicates important information and instructions.



Caution!
This symbol indicates a potentially dangerous situation.
If it is not avoided, slight or minor injuries may result.



Danger!
This symbol indicates an immediate hazard.
If it is not avoided, death or serious injuries may result.

GENERAL SAFETY INSTRUCTIONS



- These operating instructions contain important information on using the ejector. Please read the operating instructions thoroughly and keep them for later reference.



**Never look into any open or closed vacuum vents (e.g. vacuum connections or suction pads).
Serious injuries could occur as a result. Eyes can be sucked in.**

- Compressed air can cause closed containers to explode. A vacuum can cause closed containers to implode.
- The ejector may only be operated with a silencer. Never look into the exhaust air jet of the silencer.
- The ejector emits noise. We recommend wearing ear protection.
- This device is not intended for use with hazardous dust, oil mist, vapors or aerosols, etc. If drawn in, these materials will enter the exhaust air and may result in poisoning.
- Use only the connections, mounting holes and attachment materials that have been provided.
- Carry out mounting and removal only when the device is in an idle, depressurized state.
- No person may sit or stand in the area in which the load is to be transported.
- No person may sit or stand in the danger zone while the machine or system is in automatic mode.
- Components may be installed by trained specialist personnel only.

- Specialist personnel must be familiar with current safety rules and requirements. For example, these apply to the use of components such as solenoid valves and pressure switches as well as to controllers used in devices, machines and systems.
- Specialist personnel must also be familiar with the system's control concept. In particular, they must be familiar with the system's redundant control components and feedback signals.

INTENDED USE

The ejector is designed to generate a vacuum for gripping and transporting objects when used in conjunction with suction pads. Neutral gases in accordance with EN 983 are approved as evacuation media. Neutral gases include air, nitrogen and inert gases (e.g. argon, helium and neon). Aggressive gases or media such as acids, acid fumes, bases, biocides, disinfectants or detergents are not permitted.



The ejector is **not** suitable for transporting or sucking through liquids or bulk material such as granulates.
Personal injury or damage to the ejector may occur.

INSTALLATION AND OPERATION

For safe installation and trouble-free operation, please observe and comply with the following points:



The ejector may only be operated using power supply units with protected extra-low voltage (PELV). The system must incorporate safe electrical cut-off of the power supply in compliance with EN60204.



**Do not operate the ejector in environments where there is a risk of explosion.
Risk of fire and explosion.**



Output signals (discrete signals as well as IO-Link signals) can change when the power supply is switched on or the M12 connectors are plugged in. Depending on the function of the machine/system, this can result in serious personal injury or damage to the equipment.



The device may not be operated outside its specified performance limits. Doing so may cause it to malfunction or be destroyed.



During installation and maintenance, make sure that the ejector is disconnected and depressurized and that it cannot be switched on again without authorization. Personal injury or damage to the ejector may occur.

- Protect the ejector from damage at all times.
- No modifications may be made to the ejector.
- Opening the ejector will damage the “tested” labels. This voids the warranty.
- Connection symbols and labels are located on the ejector. These must be observed.
- Only the intended connections may be used.
- Pneumatic and electrical line connections must be securely connected and attached to the ejector.
- The ejector may be installed in any position.
- If these instructions are not observed, malfunctions, material damage and serious injury – including fatal injury – may result.
- If the ejector is no longer operative, the components must be disposed of in an ecologically sound manner.

2 PRODUCT OVERVIEW

GENERAL DESCRIPTION OF FUNCTIONS

VACUUM GENERATION (PICKING UP THE WORKPIECE)

The ejector is designed for vacuum handling of parts in combination with suction systems. The Venturi nozzle is activated and deactivated via the suction signal input. In the NO version, the Venturi nozzle is deactivated when the suction input signal is present. In the NC version, the Venturi nozzle is activated when the suction input signal is present.

An integrated sensor records the vacuum generated by the Venturi nozzle. This is evaluated by an electronics system and appears on the display. The measured value serves as the basis for the air saving function, switching the output and the many analysis functions of the energy process control system.

The ejector has an integrated air-saving function. The ejector automatically regulates the vacuum while in suction mode. The electronics system switches the Venturi nozzle off when the switching point H1 set by the user is reached.



If small volumes are to be evacuated, the set switching point H1 might be exceeded considerably before the vacuum is switched off. This system behavior does not constitute an error.

When objects with dense surfaces are picked up, the integrated non-return valve prevents the vacuum from dropping. If leakage causes the system vacuum to drop below the switching point H1-h1, the Venturi nozzle is switched on again.

The supply voltage is monitored by the electronics system. If the supply voltage falls below approx. 19.2 V, this is indicated by an error message. It cannot be ensured that the ejector will operate as intended below this voltage threshold.

The supply voltage's maximum permitted upper limit of approx. 26.4 V is also monitored. The display will indicate any value in excess of this limit.

BLOW-OFF (DEPOSITING THE WORKPIECE)

In blow-off mode, the vacuum circuit of the ejector is supplied with compressed air. This ensures that the vacuum drops quickly, depositing the workpiece quickly as well. Blow-off mode can be controlled externally or internally.

When controlled externally, blow-off mode is activated by the “blow-off” signal input.

When controlled internally (automatic blow-off), the blow-off valve is actuated for a defined period after suction mode is exited.

With the externally controlled automatic blow-off, the “Blow-off” valve is activated for a set amount of time once the “Blow-off” signal input is received.



The ejector also has a manual mode. In this mode, suction and blow-off can be controlled using the keys on the ejector’s foil keypad. See the “Manual mode” section for more details.

IO-LINK

The ejector can be operated in IO-Link mode to enable intelligent communication with a controller.

The ejector’s parameters can be set remotely using IO-Link mode. The energy and process control (EPC) function is also available in IO-Link mode.

Energy and process control (EPC) is divided into 3 modules:

- Condition monitoring (CM): Condition monitoring to increase system availability
- Energy monitoring (EM): Energy monitoring to optimize the vacuum system’s energy consumption
- Predictive maintenance (PM): Predictive maintenance to increase the performance and quality of the gripper systems

VERSIONS

Each ejector has a specific item designation (e.g. SCPSi-2-07-G2-NO-M12).

The item designation can be broken down as follows:

| Type | Performance class | Pneumatic connection | Idle position | Electrical connection |
|-------|-------------------|--------------------------|------------------------------|----------------------------|
| SCPSi | 2-07 | G2 (2x G1/8") | NO Normally open | M12 1xM12, 5-pin |
| | 2-09 | | NC Normally closed | |
| | 2-14 | S2 (8/6mm) S4 (6/4mm) | | |

The most important components are described below.

EJECTOR VERSION PNP OR NPN

The behavior of the ejector's electrical inputs and output can be adjusted on the device and therefore does not depend on the version.

The ejectors are factory set to PNP.

ELECTRICAL CONNECTION

The electrical connection is established using a 5-pin M12 plug that supplies the ejector with voltage, and contains the two input signals and the output signal. The inputs and output are not electrically isolated from one another.

EJECTOR DESIGN

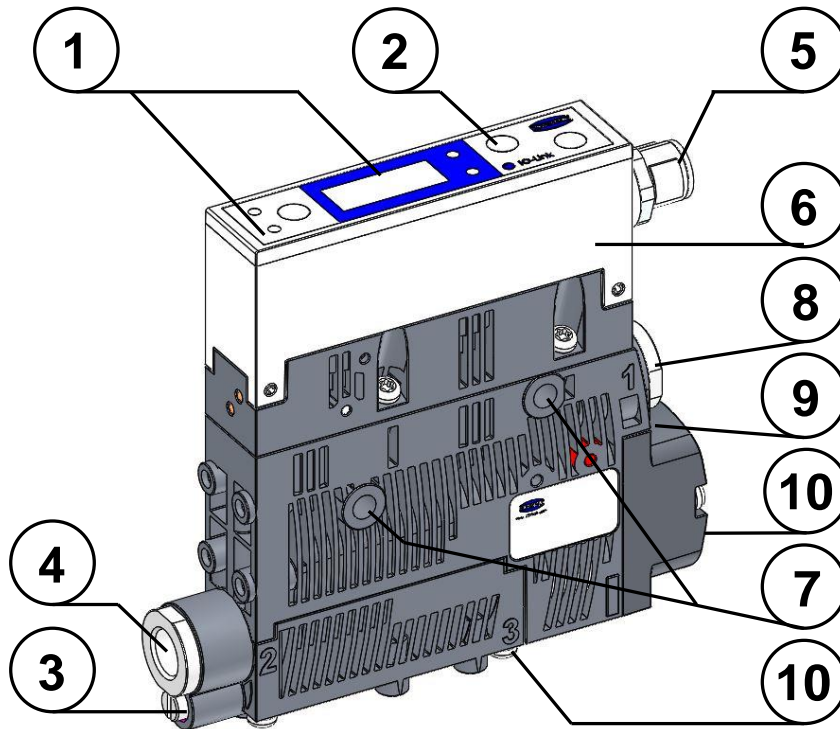

Only screw unions with cylindrical G-threads can be used at pos. 4 and pos. 8. We recommend using washers on the mounting holes. Do not look into the exhaust outlet (compressed air) during operation

| Position | Description | Max. tightening torque |
|----------|--|------------------------|
| 1 | Process state display: suction / blow-off / vacuum value | |
| 2 | Controls | |
| 3 | Blow-off valve screw | |
| 4 | G1/8" vacuum connection (label: 2 [V]) | 4 Nm |
| 5 | M12 electrical connection | Hand-tight |
| 6 | Controller | |
| 7 | Mounting holes | 2 Nm |
| 8 | Compressed air connection G1/8" in H version (label: 1 [P]) | 4 Nm |
| 9 | Silencer cover | 0,5 Nm |
| 10 | Exhaust outlet (label 3 and Silencer cover) | |

OPERATING AND DISPLAY ELEMENTS

The 3 keys, the three-digit display and 4 additional LEDs ensure simple operation of the ejector.

| | Position | Description |
|--|----------|---------------------------------|
| | 1 | Display |
| | 2 | LEDs for threshold values H1/H2 |
| | 3 | MENU button |
| | 4 | UP button |
| | 5 | DOWN button |
| | 6 | LED Process state „Suction“ |
| | 7 | LED Process state „Blow-off“ |

LEDs PROCESS STATE

The “Suction” and “Blow-off” process states are each assigned an LED.

| Process state LEDs | | Ejector status |
|-----------------------|---|---|
| <p>B ○</p> <p>S ○</p> | LEDs are both off | No suction on ejector |
| <p>B ○</p> <p>S ●</p> | Suction LED is continuously lit | Ejector is in suction state or being controlled |
| <p>B ●</p> <p>S ○</p> | Blow-off LED is continuously lit | Ejector blows off |

LEDs FOR THRESHOLD VALUES H1/H2

During conventional suction cycles, the LEDs shows the current level of the system vacuum relative to the switching points H1 and H2. Their display behavior is independent of the switching functions or assignment of the output; it is also independent of whether the condition monitoring function is active.

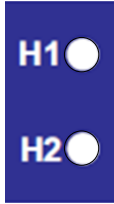
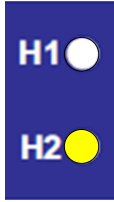
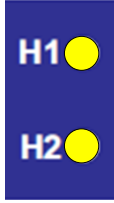
| Threshold value LEDs | | Ejector status |
|---|--|--|
|  | <p>LEDs are both off</p> | <p>Rising vacuum: Vacuum < H2</p> <p>Falling vacuum: Vacuum < (H2-h2)</p> |
|  | <p>H2 LED is continuously lit</p> | <p>Rising vacuum: Vacuum > H2 and < H1</p> <p>Falling vacuum: Vacuum > (H2-h2) and < (H1-h1)</p> |
|  | <p>LEDs are both continuously lit</p> | <p>Rising vacuum: Vacuum > H1</p> <p>Falling vacuum: Vacuum > (H1-h1)</p> |

3 DESCRIPTION OF FUNCTIONS

OPERATING MODES

The ejectors are differentiated according to their start position when in the idle state: NO (normally open) and NC (normally closed).

When the ejector is connected to the power supply, the ejector is in automatic mode and ready for operation. This is the normal operating mode, in which the ejector is operated by the system controller. A differentiation is made between SIO mode and IO-Link mode.

In addition to automatic mode, you can also use the keys on the ejector to switch to manual mode using the buttons on the foil keypad.

Parameterization of the ejector is always performed in automatic mode.

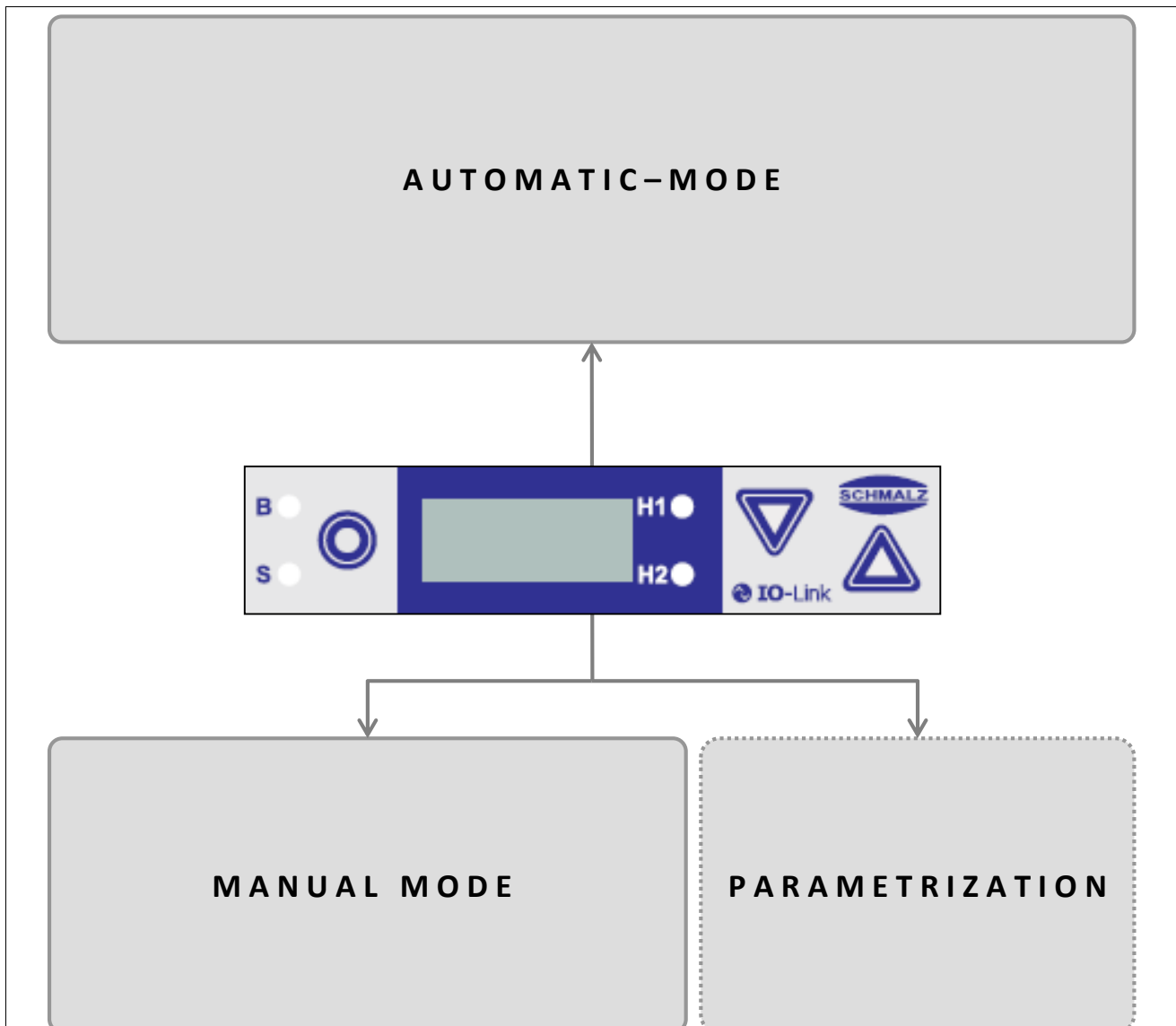

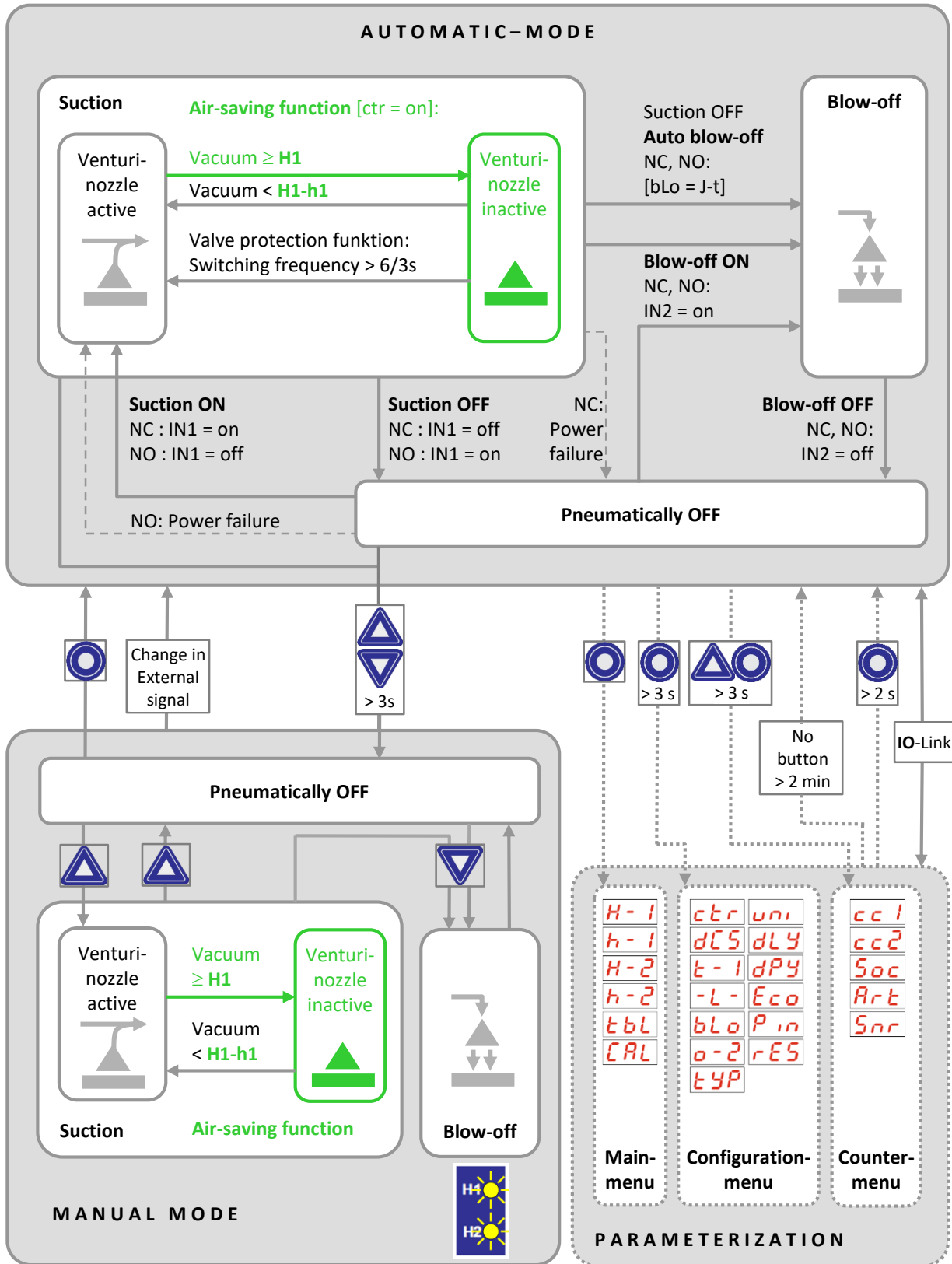

CONTROL CONCEPT FOR NO EJECTORS

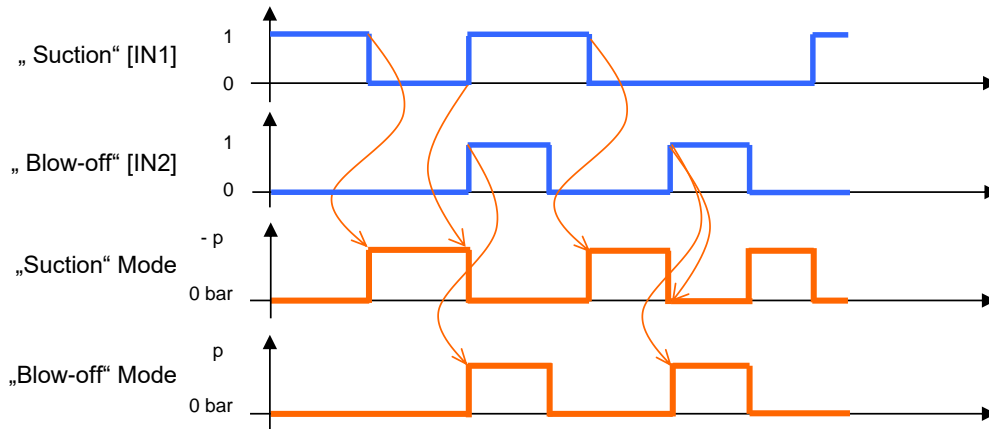

CONTROL CONCEPT FOR NC EJECTORS

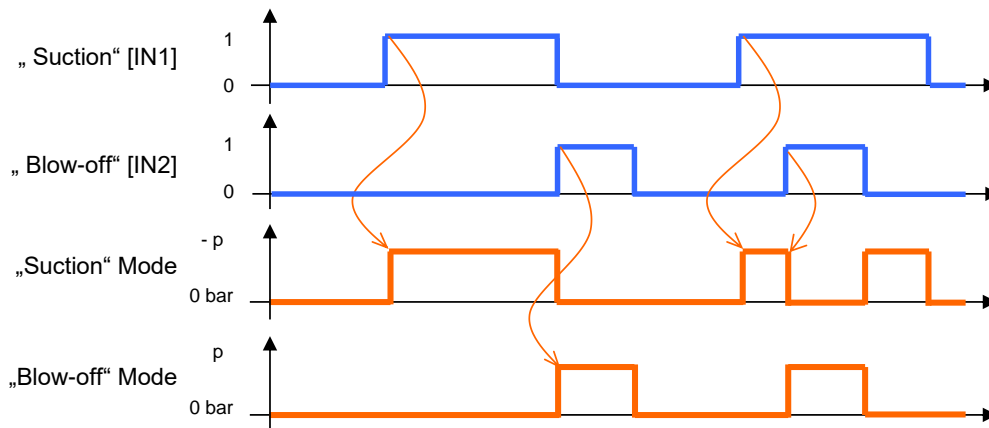

GENERAL FUNCTIONS

MANUAL MODE



The output signals may change during set-up in manual mode. Ensure that the machine or system does not start moving as a result. Personal injury or damage to the ejector could result.



In manual mode, the “Suction” and “Blow-off” ejector functions can be controlled independently of the higher-level controller using the buttons on the operating panel.

In this operating mode, the H1 and H2 LEDs both flash.

Because the valve protection function is deactivated in manual mode, this function can be used to locate and rectify leaks in the vacuum circuit.



ACTIVATING MANUAL MODE

Activate manual mode as follows:

- Press and hold the  and  buttons together for more than 3 seconds. During activation, [-M-] will appear.

When manual mode is activated, the current process state will initially be maintained.

MANUAL SUCTION

In manual mode, suction is activated by pressing the  button. Exit suction mode by pressing the  button again or by pressing the  button.



If the air-saving function is activated ([ctr=on] or [ctr=ONS]), this is also activated in manual mode.



The valve protection function is not active in manual mode.

MANUAL BLOW-OFF

Blow-off mode is activated in manual mode by pressing the  button. This mode remains active as long as the button is pressed.

DEACTIVATING MANUAL MODE

Press the  key to exit manual mode.

The operating mode will also be exited if the status of the external signal inputs changes.



This automatic exiting of manual mode due to changes in external signals can cause the object being handled to move (due to suction or blow-off).

SET-UP MODE

Similar to manual mode, set-up mode can be used to locate and rectify leaks in the vacuum circuit because the valve protection function is deactivated and because the control function is not deactivated even if the control frequency increases.

In this operating mode, the H1 and H2 LEDs both flash.

Setup mode is switched on and off using the process data output (PDO). The suction and blow-off process bits always have priority.



This function is only available in IO-Link mode.

MONITORING THE SYSTEM VACUUM

Every ejector has an integrated sensor for monitoring the current system vacuum. The vacuum level provides information on the process and has an effect on the following signals and parameters:

- Threshold value LED H1
- Threshold value LED H2
- Signal output H2
- Vacuum analog value
- Process data bits H1
- Process data bits H2

The threshold values and the corresponding hysteresis values can be set under the menu items **[H-1]**, **[h-1]**, **[H-2]** and **[h-2]** or via IO-Link.

ZERO-POINT ADJUSTMENT OF THE SENSOR (CALIBRATION)

Because the production conditions for the internally integrated sensor can vary, we recommend calibrating the sensor once it is installed in the ejector.

The pressure circuit of the system must be ventilated to ambient pressure before a zero-point adjustment can be made to the pressure sensor.



The zero point can only be shifted within a range of $\pm 3\%$ from the end value of the measurement range.



If the permissible limit of $\pm 3\%$ is exceeded, the **[E3]** error code is shown in the display.

The function for zero-point adjustment of the sensor is performed in the basic menu under **[CAL]** or using IO-Link.

CONTROL FUNCTION

With this function, the ejector allows you to save compressed air or prevent a too powerful vacuum from being generated. Vacuum generation is interrupted once the configured threshold value H1 is reached. If leakage causes the vacuum to fall below the hysteresis threshold H1-h1, vacuum generation resumes.

The following operating modes can be set for the control function in the configuration menu under the **[ctr]** menu item or via IO-Link.

No CONTROL (CONTINUOUS SUCTION)

The ejector produces continuous suction with maximum power. This setting is recommended for very porous workpieces, which would otherwise cause the vacuum generator to switch on and off continually due to the high rate of leakage.

The control function setting for this operating mode is **[oFF]**.



This setting (**[ctr = oFF]**) is only possible when control shutoff is deactivated **[dCS = oFF]**.

CONTROL

The ejector switches off the vacuum generator when the threshold H1 is reached and switches it back on when the vacuum falls below the threshold H1-h1. This setting is particularly recommended for suction-tight workpieces.

The control function setting for this operating mode is **[on]**.

CONTROL WITH LEAK MONITORING

This operating mode is the same as the previous mode, with the addition that the leakage rate within the system is measured and compared to the configurable limit value **[-L-]**. If the actual leakage rate exceeds the limit value more than twice in succession, the control function is deactivated and the ejector switches to continuous suction.

In this mode, the control function should be set to **[onS]**



When the **[onS]** function is activated, **[-L-]** is activated in the configuration menu.

DEACTIVATING THE CONTROL SHUTOFF FUNCTION

With this function, the automatic control shutoff caused by condition monitoring functions can be deactivated.

The function can be set in the configuration menu under the **[dCS]** menu item or via IO-Link.

If the function **[dCS = oFF]** is selected, the ejector switches to continuous suction mode if the leakage rate and the valve switching frequency are too high.

With the **[dCS = on]** setting, continuous suction is deactivated and the ejector continues in control mode despite high leakage and a control frequency greater than 6/3 s.



If the control shutoff function is deactivated **[dCS = on]**, the suction valve may be switched very frequently. This can destroy the ejector.



The setting **[dCS = on]** is only possible when the control function **[ctr = on]** or **[ctr = onS]** is set.



In cases of undervoltage or power failure, the ejector switches to continuous suction according to the particular ejector version (NO/NC/IMP), even if continuous suction was deactivated with the **[dCS = on]** setting.

BLOW-OFF MODES

This function is used to switch among the three blow-off modes.

The function can be set in the configuration menu under the **[bLo]** menu item or via IO-Link.

EXTERNALLY CONTROLLED BLOW-OFF

The blow-off valve is controlled directly via the blow-off signal input. The ejector switches to blow-off mode for as long as the signal is present.

The blow-off function setting for this operating mode is **[-E-]**.

INTERNALLY TIME-CONTROLLED BLOW-OFF

The blow-off valve is controlled automatically for the time period **[tbL]** after the ejector exits suction mode. This function makes it possible to save an output on the controller.

The blow-off function setting for this operating mode is **[I-t]**.



The “Blow-off” mode can still be activated in **[I-t]** mode using the “Blow-off” signal input.

EXTERNALLY TIME-CONTROLLED BLOW-OFF

The blow-off pulse is controlled externally via the blow-off input. The blow-off valve is controlled for the configured time **[tbL]**. A longer input signal does not increase the blow-off duration.

The blow-off function setting for this operating mode is **[E-t]**.



The length of the blow-off time **[tbL]** is set in the main menu. This menu item is hidden in the **[-E-]** operating mode.



The number displayed indicates the blow-off time in seconds. Blow-off times from 0.10 s to 9.99 s can be set.

SIGNAL OUTPUT

The ejector has a signal output. The signal output can be configured using the corresponding menu item.

OUTPUT FUNCTION

The signal output can be switched between **[no]** (normally open) and **[nc]** (normally closed).

You can switch it in the configuration menu using the **[o-2]** menu item, or set it using the IO-Link.

The function of the switching threshold H2/h2 (component check) is assigned to the OUT 2 signal output.

OUTPUT TYPE

The output type can be used to switch between PNP and NPN.

The signal inputs are also configured with this function.

The outputs/inputs can be switched using the **[tYP]** menu item in the configuration menu, or via IO-Link.

SELECTING THE VACUUM UNIT

This function can be used to select the units for the displayed vacuum values from the following three units.

The function can be set in the configuration menu under the **[uni]** menu item or via IO-Link.

BAR

The vacuum values are displayed in mbar.

The setting for these units is **[-bA]**.

PASCAL

The vacuum values are displayed in kPa.

The setting for these units is **[-PA]**.

INCH OF Hg

The vacuum values are displayed in inHg.

The setting for this unit is **[-iH]**.

The function can be set using the configuration menu under the menu item **[uni]** or can be set via IO-Link.



Selection of the vacuum unit only affects the display of the ejector. The units of the parameters that can be accessed via IO-Link are not affected by this setting.

SWITCH-OFF DELAY OF THE H2 COMPONENT CHECK SIGNAL

You can use this function to set a switch-off delay for the H2 component check signal. This can be used to handle short drops in the vacuum circuit.

The length of the switch-off delay is set for both outputs together via the **[dIY]** menu item in the configuration menu or via IO-Link. Values of 10, 50 or 200 ms can be selected; a value of 0 (= off) must be set to deactivate this function.



The switch-off delay affects the OUT2 discrete output, the process data bit in IO-Link and the H2 status display



If the OUT2 output is configured as a normally open contact **[no]**, there will be an electrical switch-off delay. On the other hand, if it is configured as a normally closed contact **[nc]**, there will be an equivalent switch-on delay.

ECO-MODE

The ejector offers the option to switch off the display to save energy. If eco mode is activated, the display is switched off and the power consumption is reduced after 2 minutes if no buttons are pressed.

A red dot in the lower right corner of the display indicates that the display has been switched off. The display can be reactivated by pressing any key. The display will also be reactivated if there is an error message.

ECO mode can be activated and deactivated in the configuration menu under the **[Eco]** menu item or via IO-Link.



If you activate ECO mode using IO-Link, the display will immediately enter energy-saving mode.

PIN FOR WRITE PROTECTION

A PIN code can be used to prevent the parameters from being changed using the user menu. The current settings are still displayed.

The PIN is set to 000 on delivery, meaning access to the parameters is not locked. A valid PIN between 001 and 999 must be entered in order to activate the write protection.

If write protection is activated with a customer-specific PIN, the desired parameters can be changed within one minute after the correct code is entered. If no changes are made within one minute, write protection is automatically reactivated. A PIN of 000 must be set to permanently deactivate the lock.

Full access is still possible via IO-Link even if a PIN is enabled. The current PIN can also be read out and changed/deleted (PIN = 000) via IO-Link.

The PIN is entered in the configuration menu under the menu item **[PIN]** or via IO-Link.



A PIN is recommended because carrying out parameterization while the ejector is in operation can change the status of signal inputs and outputs.

WRITE PROTECTION WITH DEVICE ACCESS LOCKS

In IO-Link mode, the “Device Access Locks” default parameter is available to prevent changes to other parameter values using the user menu or IO-Link.

You can also prevent use of the data storage mechanism described in IO-Link Standard V1.1.

| Coding of the Device Access Locks | |
|-----------------------------------|--|
| Bit | Meaning |
| 0 | Parameter write access locked (Parameters cannot be changed via IO-Link) |
| 1 | Data storage locked (Data storage mechanism is not triggered) |
| 2 | Local parametrization locked (Parameters cannot be changed via the user menu) |



Previous locking of the menu using the Device Access Locks parameter will be retained in the SIO operating mode. It can only be removed using IO-Link, not in the menu itself.

RESET TO FACTORY SETTINGS

This function restores the ejector configurations of the initial setup and the settings of the active production setup profile to the factory settings.

This function does not affect counter readings, the zero-point adjustment of the sensor or the “Application Specific Tag” IO-Link parameter.

The function is carried out in the configuration menu under the **[rES]** menu item or via IO-Link.



The factory settings of the ejector can be found in the appendix.



The function for restoring the factory settings does not affect the currently inactive production setup profiles.





Restoring the factory settings will change the switching points and the configuration of the signal output. This can change the status of the ejector system.

COUNTER

The ejector has two internal counters that cannot be deleted: **[cc1]** and **[cc2]**.

Counter 1 increases with each valid pulse at the “Suction” signal input, meaning that it counts all the suction cycles during the ejector’s service life. Counter 2 increases each time the “Suction” valve is switched on. As a result, the average switching frequency of the air saving function can be determined using the difference between counters 1 and 2.

| Symbol | Funktion | Beschreibung |
|---|----------|---|
|  | Counter1 | Counter for suction cycles (suction signal input) |
|  | Counter2 | Counter for the suction valve switching frequency |

The counters can be read out using the system menu or IO-Link.

VOLTAGE MONITORING

All ejector types have an internal voltage monitor. If the supply voltage falls below the permitted threshold, the ejector has the E07 error status. This appears in the display, and prevents menu operation and response to the signal inputs. The component check output retains its normal functionality. The current supply voltage can still be viewed using the  key.

The pneumatic state of the ejector changes as follows:

NO EJECTOR TYPE

The ejector switches to „Suction“ mode

NC EJECTOR TYPE

The ejector switches to “Pneumatically OFF” mode



The control function is canceled if the voltage drops while suction is active.

In addition, an excessive supply voltage will be detected and a corresponding error message will be generated.

EVALUATING THE INLET PRESSURE

The supply pressure level in the system cannot be measured by the ejector itself. However, it is possible to send the current measured value of the inlet pressure from the system controller to the device via IO-Link.

In this case, the ejector evaluates the pressure value and activates a condition monitoring warning if the value is not optimal. If the pressure is considerably too low or too high, an error message is also generated.

A pressure value must also be transferred to enable an estimate of the volume of compressed air consumed in the suction cycle to be made in the area of energy monitoring.

SETTING THE BLOW-OFF VOLUME FLOW

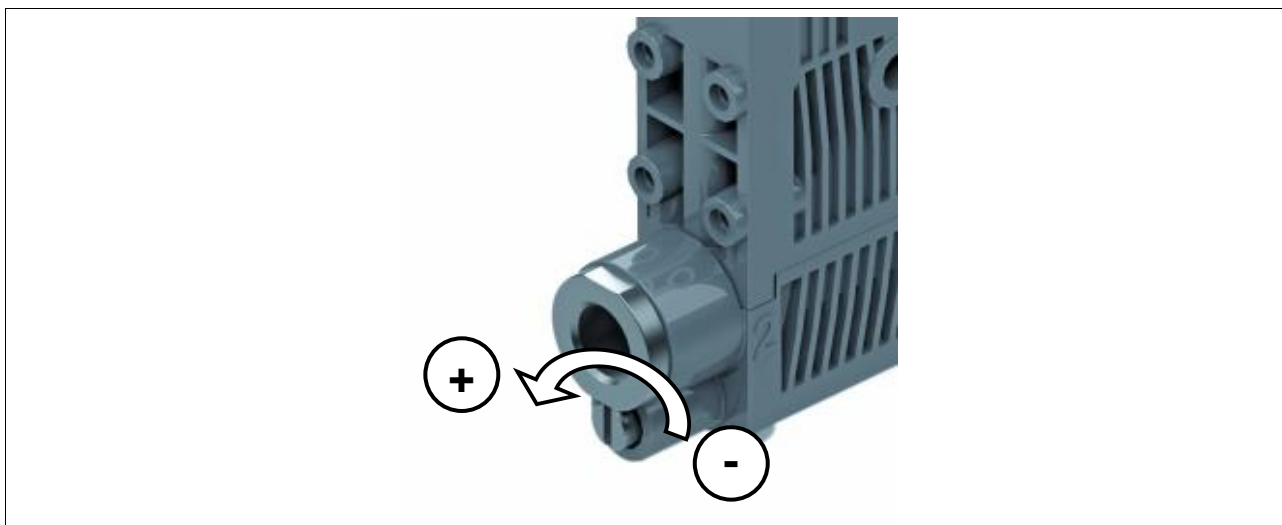

There is a valve screw below the vacuum connection (2). This valve screw can be used to set the blow-off volume flow.

Turning the screw clockwise reduces the volume flow. Turning the screw counterclockwise increases the volume flow.

The valve screw is equipped with a stop on both sides.



Do not turn the valve screw past the stops. A minimum volume flow of approx. 10% is always necessary for technical reasons.

The blow-off volume flow can be set between 10% and 100%.

PRODUCTION SETUP-PROFILES



Additional functions in IO-Link mode:

The functions described below are only available in IO-Link mode

The ejector can store up to four different production setup profiles (P-0 to P-3). All important data for workpiece handling is stored in these profiles. The profiles are selected using the PDO byte 0 process data byte. This gives users a quick, convenient option for adjusting the parameters to different workpiece properties.

The currently selected data set is displayed in the parameter data under “Production Setup”. These are also the current parameters the ejector is working with, which can be viewed using the menu.



If you select the basic menu by pressing , the parameter data set currently being used will appear briefly in IO-Link mode.



In the default setting and in SIO mode, the P-0 production setup profile is selected.

CONDITION MONITORING [CM]



Additional functions in IO-Link mode:

The functions described below are only available in IO-Link mode

MONITORING THE VALVE SWITCHING FREQUENCY

If the air-saving function is activated (**[ctr = on]** or **[ctr = onS]**) and the leakage rate in the gripper system is high, the ejector is constantly switching between the “Venturi nozzle active” and “Venturi nozzle inactive” states. The number of valve switching procedures thus increases rapidly within a short time. In order to protect the ejector and increase its service life, the ejector switches the air-saving function off automatically at a switching frequency of $> 6/3$ seconds and activates continuous suction (i.e., the ejector then remains in the “Venturi nozzle active” state).

The basic monitoring of valve protection function is also active in the SIO mode.

In IO-Link mode, the appropriate condition monitoring warning is also set. In addition, the system status light switches to yellow.



The **[dCS = ON]** setting prevents continuous suction.

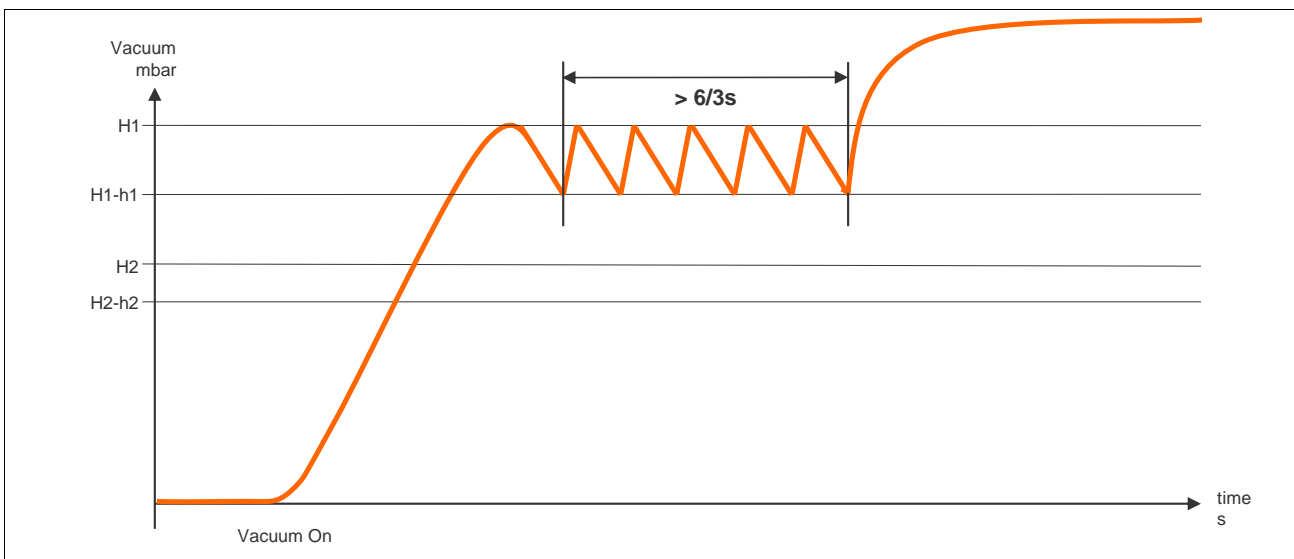

MONITORING THE CONTROL THRESHOLD

If the switching point H1 is never reached during the suction cycle, the “H1 not reached” condition monitoring warning will be triggered and the system status light will switch to yellow.

This warning is available at the end of the current suction phase and remains active until the next suction cycle.

MONITORING THE EVACUATION TIME

If the measured evacuation time t_1 (from H2 to H1) exceeds the specified value **[t-1]**, the “Evacuation time longer than t-1” condition monitoring warning will be triggered and the system status light will switch to yellow.

The specified value for the max. permitted evacuation time can be set in the configuration menu under **[t-1]** or using IO-Link. Setting the value to 0 (= off) deactivates monitoring. The maximum permitted evacuation time setting is 9.99 s.

MONITORING LEAKAGE

In control mode (**ctr = onS**), the drop in the vacuum level within a certain time is monitored (mbar/s). A distinction is made between two states.

| Leakage $L < [-L-]$ | Leakage $L > [-L-]$ |
|--|--|
| <p>If the leakage rate is less than the set value [-L-] in mbar/s, the vacuum level continues to fall until the switching point H1-h1 and then the ejector resumes suction (normal control mode).</p> <p>The condition monitoring warning is not activated and there is no effect on the system status light.</p> | <p>If the leakage rate is greater than the value [-L-], the ejector immediately reacts to correct the vacuum level.</p> <p>If the permitted leakage is exceeded twice, the ejector switches to continuous suction.</p> <p>The condition monitoring warning is activated and the system status light switches to yellow.</p> |
| | |



The **[dCS = ON]** setting prevents continuous suction.

MONITORING THE DYNAMIC PRESSURE

If possible, a dynamic pressure measurement is taken at the start of every suction cycle. The result of this measurement is compared to the threshold values set for H1 and H2.

If the dynamic pressure is greater than (H2 – h2) but less than H1, the corresponding condition monitoring warning will be set and the system status light will switch to yellow.

EVALUATING THE LEAKAGE LEVEL

This function determines the average leakage during the last suction cycle, divides it into subareas and makes it available as a parameter via IO-Link.

MEASUREMENT OF THE EVACUATION TIME t_0

This measures the time (in ms) from the beginning of a suction cycle, started by the command "Suction ON", until the switching threshold H2 is reached.

MEASUREMENT OF THE EVACUATION TIME t_1

This measures the time (in ms) from when the switching threshold H2 is reached until the switching threshold H1 is reached.

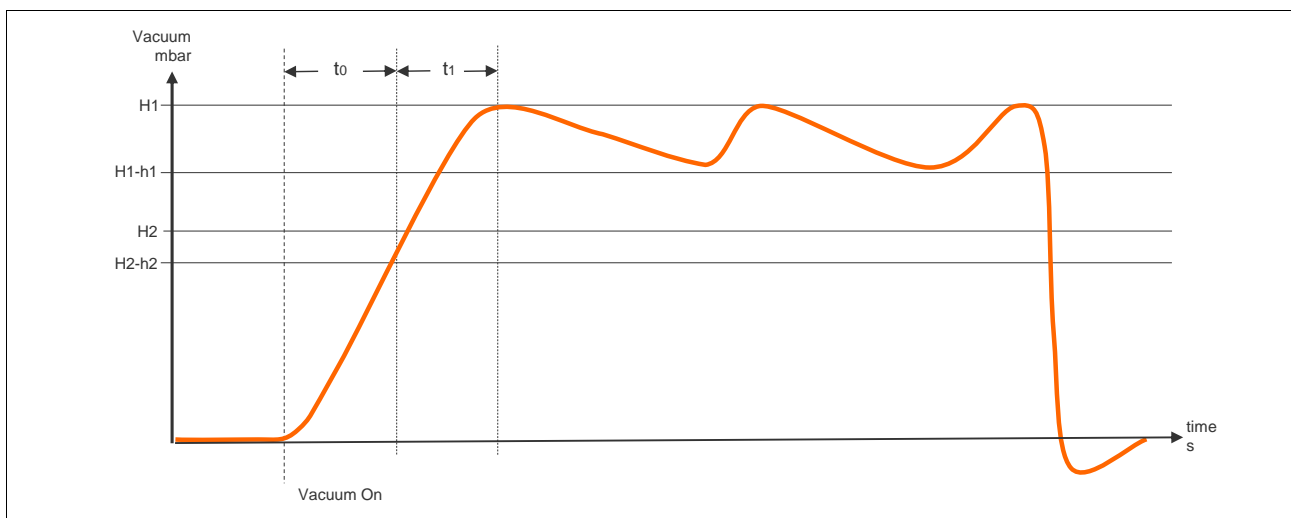

AUTOSET

The CM Autoset IO-Link function in the process output data allows the condition monitoring parameters for maximum permitted leakage (-L-) and evacuation time (t_1) to be set automatically. The actual values from the last suction cycle are combined with additional tolerance and stored.

ENERGY MONITORING [EM]



Additional functions in IO-Link mode:

The functions described below are only available in IO-Link mode

The ejector offers functions for measuring and displaying the energy consumption to help further optimize the energy efficiency of vacuum gripper systems.



The values are determined from comparison tables according to current process parameters. Although the ejector is not a calibrated measuring device, the values can be used as a reference and for relative measurements.

PERCENTUAL AIR CONSUMPTION MEASUREMENT

All ejectors calculate the percentual air consumption of the last suction cycle. This value corresponds to the ratio of the active suction/blow-off times to the total duration of the suction cycle.

ABSOLUTE AIR CONSUMPTION MEASUREMENT

An externally recorded pressure value can be supplied using the IO-Link process data. If this value is available, not only a percentage-based air consumption measurement, but also an absolute air consumption measurement can be performed.

The actual air consumption of a suction cycle is calculated by taking into account the system pressure and the nozzle size.



An absolute air consumption measurement can only be made using a pressure value supplied externally via IO-Link.

ENERGY CONSUMPTION MEASUREMENT

The ejector determines the electrical energy consumed during a suction cycle, including the energy it consumes itself and the energy consumed by the valve coils.

PREDICTIVE MAINTENANCE [PM]



Additional functions in IO-Link mode:

The functions described below are only available in IO-Link mode

For early detection of wear and other impairments to the vacuum gripper system, the ejector features functions for detecting trends in the system's quality and performance. Leakage and dynamic pressure are measured for this purpose.

MEASUREMENT OF THE LEAKAGE

This measures the leakage (drop in vacuum level per unit of time in mbar/s) after the control function has halted suction because the threshold value H1 was reached.

MEASUREMENT OF THE DYNAMIC PRESSURE

This measures the system vacuum achieved during unobstructed intake. The duration of the measurement is approx. 1 s. To perform a valid dynamic pressure value evaluation, it is therefore necessary to allow the ejector to suck in air unobstructed for at least 1 s after suction begins, i.e., the suction cell must not yet be covered by a component.

Measured values that are above the threshold value H1 are output as 0 mbar to indicate that a valid dynamic pressure measurement could not be performed.

Measured values that are greater than the threshold value (H2 – h2) but less than the threshold value H1 trigger a condition monitoring event.

QUALITY ASSESSMENT

To evaluate the entire gripper system, the ejector calculates a quality assessment value based on the measured leakage in the system.

The greater the leakage in the system, the poorer the quality of the gripper system. Accordingly, low leakage leads to a high quality assessment value.

PERFORMANCE CALCULATION

Similar to the quality assessment, the performance calculation is used to assess the system state. The measured dynamic pressure can be used as a measure of the performance of the gripper system.

Optimally designed gripper systems lead to low dynamic pressures and thus high performance; poorly designed systems result in low performance values.

Dynamic pressure measurements that are greater than the threshold value (H2– h2) always result in a performance rating of 0%. A performance rating of 0% is also issued for a dynamic pressure of 0 mbar (which serves as an indication that the measurement was not valid).

DIAGNOSTIC BUFFER

The condition monitoring warnings described above and the general error messages from the device are saved in a diagnostic buffer.

The content of this memory is made up of the last 38 events, starting with the most recent, and can be read out via an IO-Link parameter. For each event, the current reading of the suction cycle counter cc1 is also saved to allow subsequent temporal assignment of the events to other processes in the system. See the associated IO-Link Data Dictionary for the actual data display of the diagnostic buffer.

The recording of these events is also active in SIO mode and the contents of the memory is retained after a power failure. The memory is deleted manually using the IO-Link system command "Clear diagnostic buffer" or also by restoring the factory settings on the device.

EPC DATA BUFFER

The ejector provides a ten-stage data buffer to enable long-term monitoring and trend analysis of the most important key figures in a handling process. The current measurement values for the evacuation time t1, the leakage rate and the dynamic pressure (vacuum during unobstructed intake) determined during the suction cycle can be saved in this buffer.

The values are saved automatically, always together with the execution of the Autoset function in condition monitoring described above. For each data record, the current reading of the suction cycle counter cc1 is also saved to allow subsequent temporal assignment to other processes in the system. The contents of the EPC data buffer can be read out via an IO-Link parameter. See the associated IO-Link Data Dictionary for the actual data display of this buffer. The contents of the memory remains intact after a power failure.

4 OPERATING AND MENU CONCEPTS

The unit is operated via four buttons on the foil keypad. Settings are made using software menus. The operating structure is divided into settings in the main menu and in the configuration menu. Configuring the ejector in the main menu is sufficient for standard applications. An extended configuration menu is available for applications with special requirements.



If settings are changed, this can cause undefined changes to the system status for a short period of time (approx. 50 ms) in certain situations.

VACUUM DISPLAY

The ejector is in display mode when the menus are not being accessed. The current vacuum or the current system pressure is displayed.

If there is overpressure in the suction circuit, this is indicated by the ejector with the display “-FF”. This normally always happens in blow-off mode.

An excessive vacuum value (outside of the measurement range) is indicated by the display “FFF”.

INDIVIDUAL FUNCTIONS

In display mode, a specific function is assigned to each key.

SUPPLY VOLTAGE

Pressing the  key displays the supply voltage currently applied to the ejector.

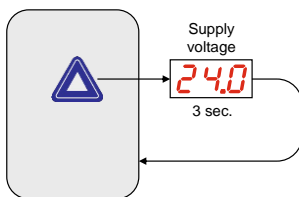



The display returns to the vacuum display after 3 s.



The ejector is not a calibrated measuring device, but the voltage displayed can still be used as a reference value and for comparative measurements.

OPERATING MODE DISPLAY

Pressing  displays the current operating mode, either standard I/O (SIO) mode or IO-Link mode. In IO-Link mode, you can also press  again to view the IO-Link Standard (1.0, 1.1) currently in use.

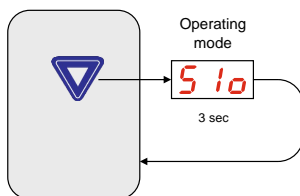

The display returns to the vacuum display after 3 s.

ERROR DISPLAY

If an error occurs, it appears on the display in the form of an error code (E number). The ejector's response to an error depends on the type of error.

You can find a list of possible errors and the corresponding codes in Sec. 7.

Any operation being performed in the menu will be interrupted if an error occurs. The error code can also be opened as a parameter using IO-Link.

MAIN MENU



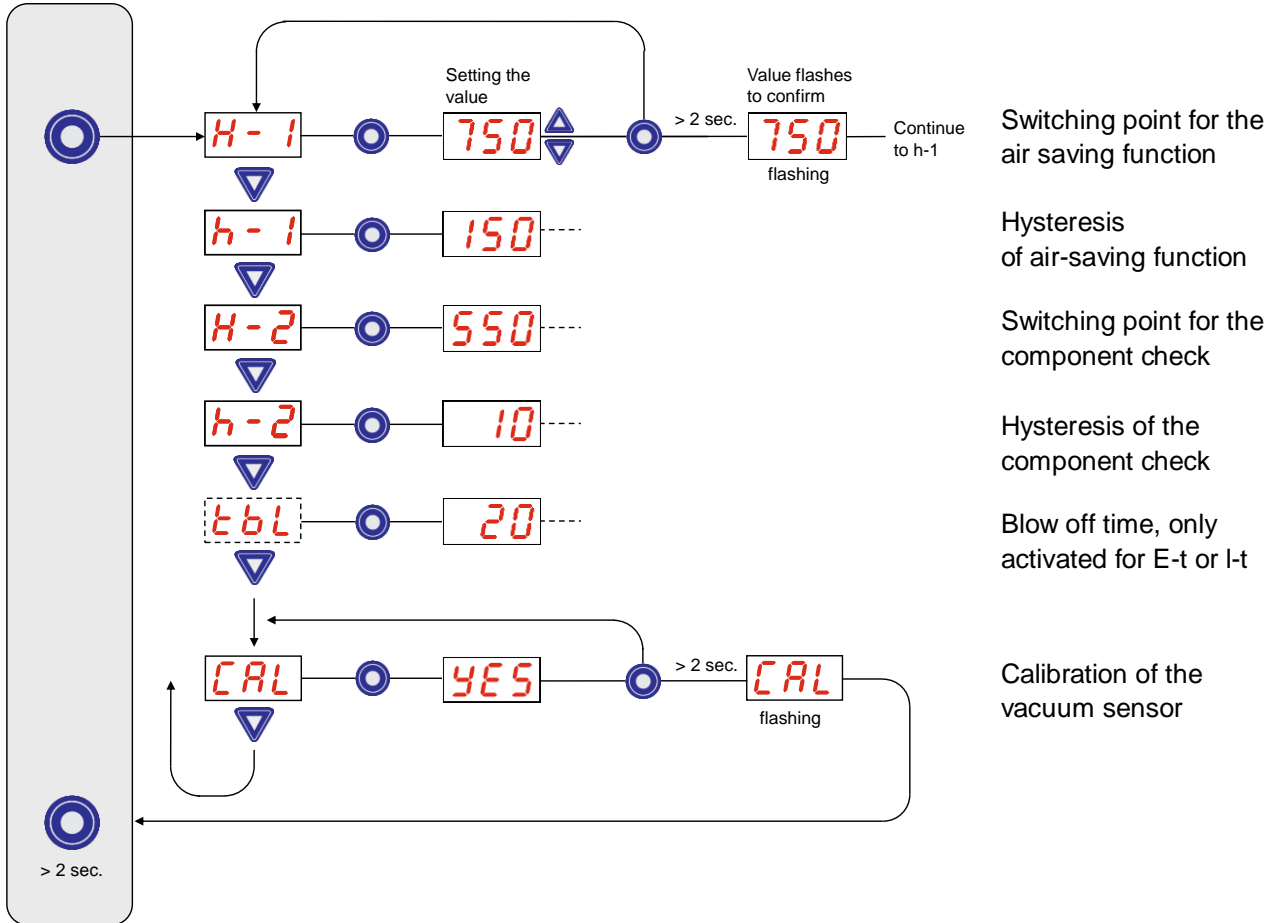



All settings for standard ejector applications can be read and changed using the main menu.







Functions shown in dotted lines are only available in certain functional scenarios.

SETTING THE PARAMETERS IN THE MAIN MENU

Briefly press the  button to set the parameters in the main menu.

- Select the desired parameter using the  and  buttons.
- Confirm by pressing the  button.
- Change the value using the  and  buttons.
- Press the  button > 2 s to save the changed value.





 If the  or  button is pressed for approx. 3 seconds, the value to be changed begins to quickly scroll through the available options.

 If you exit the changed value by briefly pressing , the value will not be applied.

 To exit the basic menu press the  key > 2 s.

ZERO-POINT ADJUSTMENT (CALIBRATION)

Briefly press the  button to adjust the zero point of the integrated sensors.

- Press  or  until **[CAL]** appears in the display.
- Use the  key to confirm, and once **[YES]** appears, press the  key > 2 s. The vacuum sensor is only calibrated

CONFIGURATION MENU

An extended configuration menu is available for applications with special requirements. The operating structure is as follows:

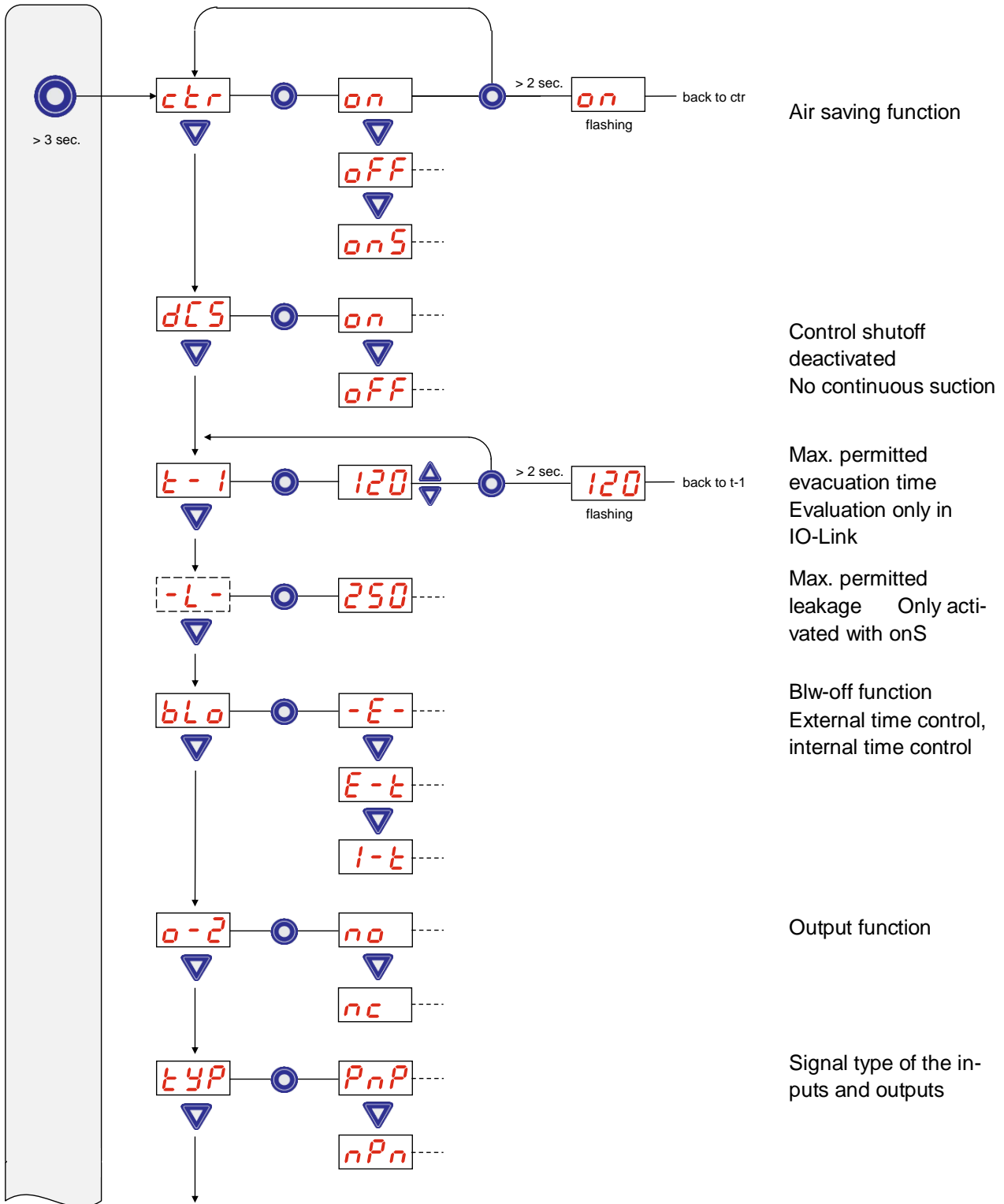

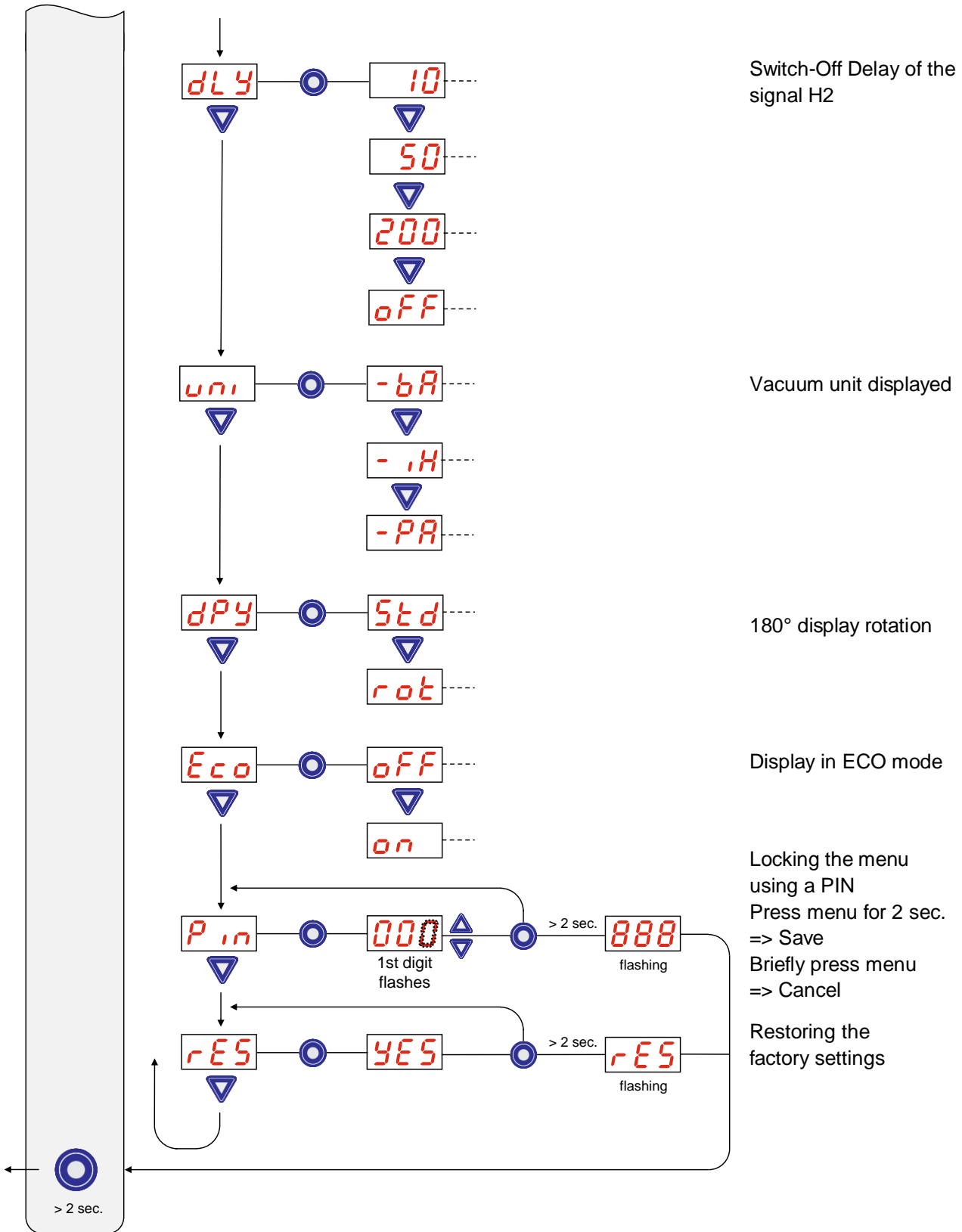

Switch-Off Delay of the signal H2

Vacuum unit displayed

180° display rotation







Display in ECO mode

Locking the menu using a PIN
 Press menu for 2 sec.
 => Save
 Briefly press menu
 => Cancel



Restoring the factory settings

SETTING THE PARAMETERS IN THE CONFIGURATION MENU

Press the  button for longer than 3 s to set the parameters in the configuration menu. During activation, **[-C-]** will appear.

- Select the desired parameter using the  and  buttons.
- Confirm by pressing the  button.
- Change the value using the  or  button.
- Press the  button > 2 s to save the changed value.



If the  or  button is pressed for approx. 3 seconds, the value to be changed begins to quickly scroll through the available options.











If you exit the changed value by briefly pressing , the value will not be applied.



To exit the configuration menu press the  key > 2 s.

ENTERING THE PIN





Press the  for longer than 3 s to enter the PIN.

- Use the  and  buttons to select the **[Pin]** menu item.
- Confirm by pressing the  button.
- Enter the first digit of the PIN code using the  and  buttons.
- Confirm by pressing the  button.
- Enter the remaining digits in the same way.
- Press the  button for longer than 2 seconds to save the PIN.

[Loc] flashes in the display and the configuration menu is exited.

EXECUTING THE “RESET TO FACTORY SETTINGS” FUNCTION

Press the  button for longer than 3 seconds to execute this function.

- Use the  and  buttons to select the **[rES]** menu item.
- Use the  key to confirm, and once **[YES]** appears, press the  key > 2 s. The ejector is now restored to the factory settings.

After confirmation, the display flashes for three seconds and then automatically returns to display mode.

SYSTEM MENU

A special menu is available for reading out system data such as counters, software version, part numbers and serial numbers. The operating structure is as follows:

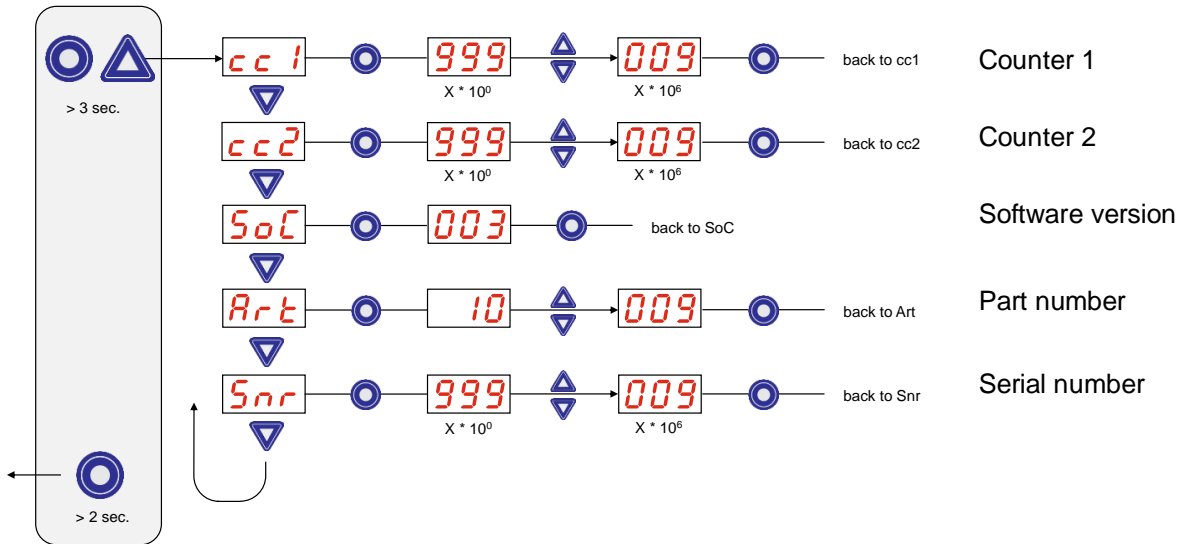

VIEWING DATA IN THE SYSTEM MENU

To view data in the system menu, press and at the same time for more than 3 seconds. During activation, [-S-] will appear.

- Use or to select the value to be displayed
- Confirm using the key. The value is displayed
- To exit the system menu, press the key > 2 s



VIEWING THE COUNTERS

This menu item displays the **[cc1]** (suction cycles) and **[cc2]** (number of valve switches) counters.

The last three decimal places of the total counter value are displayed. The decimal point at the far right flashes. This corresponds to the three-digit block with the lowest significance.

The remaining decimal places of the total counter value can be displayed using the and buttons. The decimal points indicate which three-digit block of the total counter value is shown in the display.

The total counter value consists of all the three-digit blocks together:

| Displayed places | 10^6 | 10^3 | 10^0 |
|------------------|---|--|---|
| Block of digits |  |  |  |

The current total counter value in this example is 48 618 593.



SOFTWARE VERSION

The software version indicates the software currently running on the internal controller.



SERIAL NUMBER

The serial number indicates the period in which the ejector was manufactured.

The last three decimal places of the serial number are displayed. The decimal point at the far right flashes. This corresponds to the three-digit block with the lowest significance.

The remaining decimal places of the serial number can be displayed using the  and  buttons. The decimal points indicate which three-digit block of the serial number is shown in the display.

The serial number consists of all the three-digit blocks together:

| Displayed places | 10^6 | 10^3 | 10^0 |
|------------------|---|--|---|
| Block of digits |  |  |  |





The current serial number in this example is 48 618 593.

ARTICLE NUMBER

The part number both appears on the label on the ejector, and is stored electronically.

The first two places of the article number are shown initially. Press the  button to display the remaining places of the article number. The decimal points displayed are part of the article number. The article number consists of 11 places in total.

The part number consists of 4 digit blocks with 11 numbers.

| | 1 | 2 | 3 | 4 |
|-----------------|---|---|--|---|
| Block of digits |  |  |  |  |

The article number in this example is 10.02.02.003830.



To exit the system menu, press the  key > 2s.

5 OPERATING MODE

All ejectors of the SCPSi series have two operating modes. Users can choose between direct connection to inputs and outputs (serial I/O = SIO mode) or connection through the communication line (IO-Link).

By default, the ejector always runs in SIO mode, but it can be switched in and out of IO-Link mode by an IO-Link master at any time.

SIO OPERATING MODE

OVERVIEW

When the ejector is operated in SIO mode, all signal inputs and outputs are connected to a controller either directly or via intelligent connection boxes.

In addition to the power supply connection, this mode requires two signal inputs and one signal output, via which the ejector communicates with the controller.

This means that the ejector's basic suction and blow-off functions, as well as the "Component check" feedback function, can be used.

| Ejector inputs | Ejector output |
|---|---|
| <ul style="list-style-type: none"> ▪ Suction ON/OFF ▪ Blow-off ON/OFF | <ul style="list-style-type: none"> ▪ Feedback H2 (component check) |

The "Blow-off" signal does not have to be used if the ejector is operated with internal time control in blow-off mode. This allows operation on a single port in a configurable terminal box (using 1xDO and 1xDI).

The parameters are set and the internal counters are read exclusively via the operating and display elements.

Neither the condition monitoring (CM) events, nor the energy monitoring (EM) and predictive maintenance (PM) functions are available in SIO mode.

MOUNTING

SCPSi-2 ...

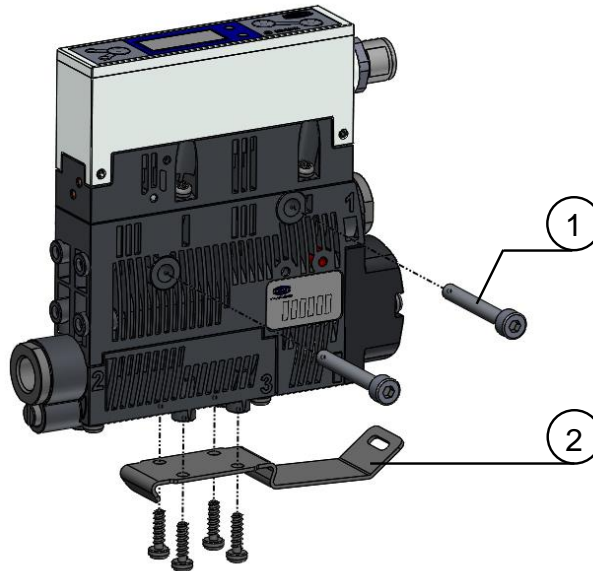

We recommend using washers when mounting the securing screws.

| Position | Description | Max. tightening torque |
|----------|---|------------------------|
| 1 | M4 securing screw | 2 Nm |
| 2 | Top-hat rail clamp for TS35 top-hat rail, incl. plastic tapping screws (optional) | 0,5 Nm |

PNEUMATIC CONNECTION

- Use only well-maintained compressed air (air or neutral gas according to EN 983, filtered to 5 µm, oiled or unoled).
- High-quality compressed air is important to ensure a long service life for the ejector.
- Dirt particles or foreign bodies in the ejector connections, hoses or pipelines can lead to partial or complete ejector malfunction.
- Hoses and pipelines should be laid such that distances are minimized.
- If the internal diameter on the compressed air side is too small, insufficient compressed air will be supplied. This prevents the ejector from performing as specified in the performance data.
- Excessive flow resistance occurs if the internal diameter on the vacuum side is too small. This leads to both a reduction in suction capacity and increased evacuation times. Blow-off times are also lengthened.
- Hose lines must be laid without bends or crimps.
- Only use hoses or pipes with the internal diameters recommended for the ejector. If this is not possible, use the next largest internal diameter.

RECOMMENDED LINE CROSS-SECTIONS (INTERNAL DIAMETERS)

| SCPSi performance class | Line cross-section (internal diameter) [mm] ¹⁾ | |
|-------------------------|---|-------------|
| | Compressed air side | Vacuum side |
| 07 | 4 | 4 |
| 09 | 4 | 4 |
| 14 | 4 | 6 |

¹⁾ Based on a maximum hose length of 2 m. For longer hoses, the cross-section should be correspondingly larger.

ELECTRICAL CONNECTION

- The electrical connection of the ejector consists of an 5-pin M12 connector.
- The plug connector may not be connected or disconnected while voltage is applied.
- The ejector may only be operated using power supply units with protected extra-low voltage (PELV). The system must incorporate safe electrical cut-off of the power supply in compliance with EN60204.
- The lines for the power supply, the signal inputs and the signal output can have a maximum length of 30 meters.

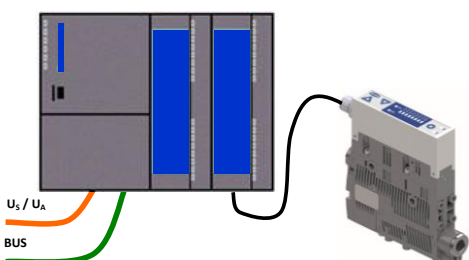
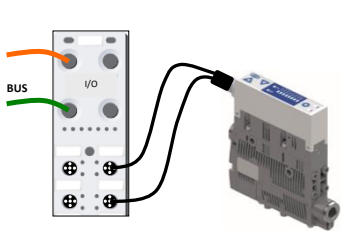
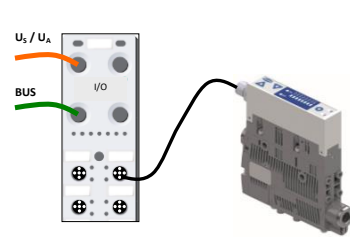
| Direct connection | Connection via I/O box | |
|--|--|--|
|  |  |  |
| <p>Schmalz connection lines may be used to connect the ejector directly to the controller.</p> <ul style="list-style-type: none"> ▪ Art. no. 21.04.05.00080 (5-pin) | <p>Schmalz connection distributors and Schmalz connection lines may be used to connect the ejector to IO boxes.</p> <ul style="list-style-type: none"> ▪ Art.-No. 10.02.02.03490 M12-5 to 2xM12, 1m | <ul style="list-style-type: none"> ▪ Art.-No. 21.04.05.00158 M12-5 to M12-5, 1m |

PIN ASSIGNMENT OF THE CONNECTION PLUG

M12 5-PIN CONNECTOR

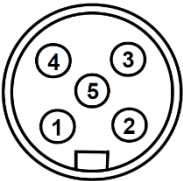
| Plug | Pin | Lead color ¹⁾ | Symbol | Function |
|---|-----|--------------------------|-------------|---|
|  | 1 | Brown | $U_{S/A}$ | Supply voltage for sensors/actuators |
| | 2 | White | IN1 | “Suction” signal input |
| | 3 | Blue | $Gnd_{S/A}$ | Ground for sensors/actuators |
| | 4 | Black | OUT | “Component check” signal output (H2/h2) |
| | 5 | Gray | IN2 | “Blow-off” signal input |

¹⁾ When Schmalz connection line is used, art. no. 21.04.05.00080



The system may only be operated using power supply units with protected extra-low voltage (PELV) and safe electrical cut-off of the operating voltage, in accordance with EN60204.

Do not forcibly connect or disconnect plug connectors.



The signal output may change if the supply voltage is switched on or the M12 plug connector is plugged in. Depending on the function of the machine/system, this can result in serious personal injury or damage to the equipment.

PROJEKTIEREN

For operation of the ejector, all process signals must be wired in parallel. This means that three lines for the process signals are required for each ejector.

PROCESS DATA INPUT













| Signal | Symbol | Parameter |
|--------|--------|--------------------------------------|
| 0 | OUT 1 | Switching point H2 (component check) |



PROCESS DATA OUTPUT

| Signal | Symbol | Parameter |
|--------|--------|-----------------|
| 0 | IN 1 | Suction ON/OFF |
| 1 | IN 2 | Blow-off ON/OFF |

START OF OPERATIONS

A typical handling cycle is divided into three steps: pick-up, blow-off and the idle state. During the pick-up step, output 2 is monitored to determine whether a sufficient vacuum has been established.

| Step | SCPS – xx – NO – xx | | SCPS – xx – NC – xx | |
|------|--|------------------|--|------------------|
| | Signal | State | Signal | State |
| 1 |  IN1 | Saugen EIN |  IN1 | Saugen EIN |
| 2 |  OUT2 | Vakuum > H2 |  OUT2 | Vakuum > H2 |
| 3 |  IN1 | Saugen AUS |  IN1 | Saugen AUS |
| 4 |  IN2 | Abblasen EIN |  IN2 | Abblasen EIN |
| 5 |  IN2 | Abblasen AUS |  IN2 | Abblasen AUS |
| 6 |  OUT2 | Vakuum < (H2-h2) |  OUT2 | Vakuum < (H2-h2) |









 Signal status switches from inactive to active |  Signal status switches from active to inactive

WARNINGS AND ERRORS**WARNINGS**

Warnings are only available via IO-Link.

ERROR

Error messages from the ejector are shown in the display.

| Symbol | Error code |
|---|---|
|  | Electronics error - EEPROM |
|  | Electronics error – internal communication |
|  | Zero point of vacuum/pressure sensor adjusted outside of $\pm 3\%$ FS |
|  | Supply voltage is too low |
|  | Short-circuit at output 2 |
|  | Supply voltage is too high |
|  | Current vacuum or pressure exceeds the measurement range |
|  | Excess pressure in the vacuum circuit |

IO-LINK MODE

OVERVIEW

When operating the ejector in IO-Link mode (digital communication), only the power supply and the communication line must be connected to a controller directly or via intelligent connection boxes.

The communication line for IO-Link (C/Q line) must always be connected to an IO-Link master port (point-to-point connection). It is not possible to connect multiple C/Q lines to only one IO-Link master port.

When the ejector is connected via IO-Link, a number of additional functions are available beyond the basic functions of the ejector (suction, blow-off, feedback signals, etc.). This includes but is not limited to:

- Current vacuum and pressure value
- Selection of four production profiles
- Errors and warnings
- Ejector system status display
- Access to all parameters
- Counters
- Condition monitoring
- Energy monitoring
- Predictive Maintenance

In this mode, all adjustable parameters can be read, changed and written to the ejector directly using the higher-level controller.

The condition and energy monitoring results can be evaluated to produce trend analyses and to provide direct information on the current handling cycle.

The ejector supports the IO-Link revision 1.1 with four bytes of input data and two bytes of output data.

It is also compatible with IO-Link masters that use the 1.0 revision. In this case, one byte of input data and one byte of output data are supported.

The exchange of process data between the IO-Link master and the ejector is cyclical. Parameter data (acyclical data) is exchanged by the user program in the controller using communication modules.

MOUNTING

SCPSi-2 ...

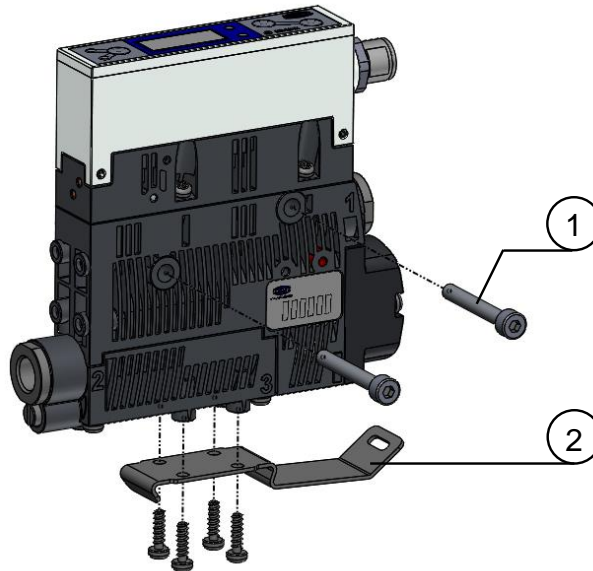

We recommend using washers when mounting the securing screws.

| Position | Description | Max. tightening torque |
|----------|---|------------------------|
| 1 | M4 securing screw | 2 Nm |
| 2 | Top-hat rail clamp for TS35 top-hat rail, incl. plastic tapping screws (optional) | 0,5 Nm |

PNEUMATIC CONNECTION

- Use only well-maintained compressed air (air or neutral gas according to EN 983, filtered to 5 µm, oiled or unoled).
- High-quality compressed air is important to ensure a long service life for the ejector.
- Dirt particles or foreign bodies in the ejector connections, hoses or pipelines can lead to partial or complete ejector malfunction.
- Hoses and pipelines should be laid such that distances are minimized.
- If the internal diameter on the compressed air side is too small, insufficient compressed air will be supplied. This prevents the ejector from performing as specified in the performance data.
- Excessive flow resistance occurs if the internal diameter on the vacuum side is too small. This leads to both a reduction in suction capacity and increased evacuation times. Blow-off times are also lengthened.
- Hose lines must be laid without bends or crimps.
- Only use hoses or pipes with the internal diameters recommended for the ejector. If this is not possible, use the next largest internal diameter.

RECOMMENDED LINE CROSS-SECTIONS (INTERNAL DIAMETERS)

| SCPSi performance class | Line cross-section (internal diameter) [mm] ¹⁾ | |
|-------------------------|---|-------------|
| | Compressed air side | Vacuum side |
| 07 | 4 | 4 |
| 09 | 4 | 4 |
| 14 | 4 | 6 |

¹⁾ Based on a maximum hose length of 2 m. For longer hoses, the cross-section should be correspondingly larger.

ELECTRICAL CONNECTION

- The electrical connection of the ejector consists of an 5-pin M12 connector.
- The plug connector may not be connected or disconnected while voltage is applied.
- The ejector may only be operated using power supply units with protected extra-low voltage (PELV). The system must incorporate safe electrical cut-off of the power supply in compliance with EN60204.
- The lines for the power supply, the signal inputs and the signal output can have a maximum length of 20 meters.

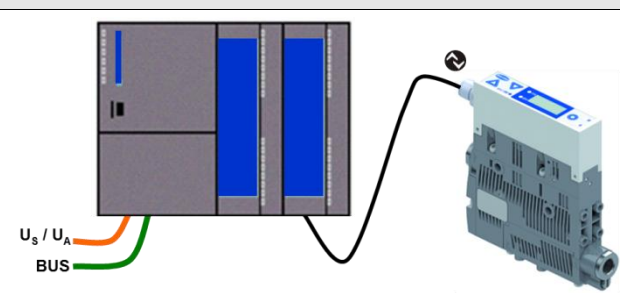
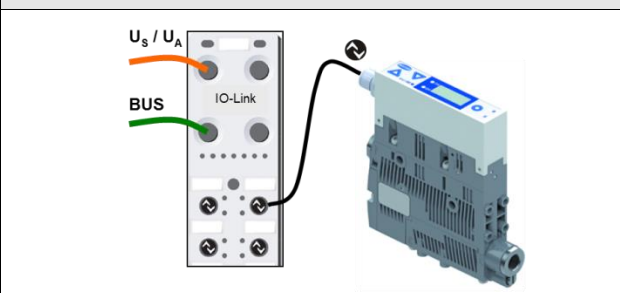
| Direct connection | Connection via I/O box |
|---|---|
|  <p>A Schmalz connection line may be used to connect the ejector directly to the controller.</p> <ul style="list-style-type: none"> ▪ Art.-No. 21.04.05.00080 |  <p>A Schmalz connection line may be used to connect the ejector to IO-Link master boxes.</p> <ul style="list-style-type: none"> ▪ Art.-No. 21.04.05.00158 |

PIN ASSIGNMENT OF THE CONNECTION PLUG

M12 5-PIN CONNECTOR

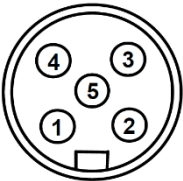
| Plug | Pin | Lead color ¹⁾ | Symbol | Function |
|---|-----|--------------------------|--------------------|--------------------------------|
|  | 1 | Brown | U _{S/A} | Power supply Sensor / Actuator |
| | 2 | White | - | - |
| | 3 | Blue | Gnd _{S/A} | Sensor / Actuator ground |
| | 4 | Black | C/Q | IO-Link communication line |
| | 5 | Gray | - | - |

¹⁾ When Schmalz connection line is used, art. no. 21.04.05.00080



The system may only be operated using power supply units with protected extra-low voltage (PELV) and safe electrical cut-off of the operating voltage, in accordance with EN60204.

Do not forcibly connect or disconnect plug connectors.



The signal output may change if the supply voltage is switched on or the M12 plug connector is plugged in. Depending on the function of the machine/system, this can result in serious personal injury or damage to the equipment.

PROJECT PLANNING

To operate the ejector in IO-Link mode, you only need to connect an IO-Link connection line (C/Q) in addition to the power supply. Each ejector therefore only requires one line for all process and parameter data.

The ports on an IO-Link master typically have to be switched to IO-Link mode first. This is done using the configuration tool supplied by the manufacturer of the master or controller. The port can be configured generically for IO-Link by entering the correct process data length for the IO-Link device and possibly also storing standard settings for the required manufacturer ID and device ID in the master.

Alternatively, the electronic device description file, or IODD, can be used. To do this, an IO-Link configuration tool from the master manufacturer must be available into which the IODD is imported. This kind of tool displays all process and parameter data for the device in a meaningful format and enables convenient offline parameterization or also observation during operation.

For the devices in the SCPSi series, the IODD is available to download in two versions from www.schmalz.com:

- IODD in accordance with the revision 1.1, for use with current IO-Link masters The full range of functions is available with 4 bytes of input data and 2 bytes of output data
- IODD in accordance with the revision 1.0, for use with older IO-Link masters (legacy mode). The range of functions is slightly limited; the process data is limited to 1 byte of input data and 1 byte of output data.

For example, when using Siemens components, the IODD for the ejector is displayed as follows in the program S7-PCT.

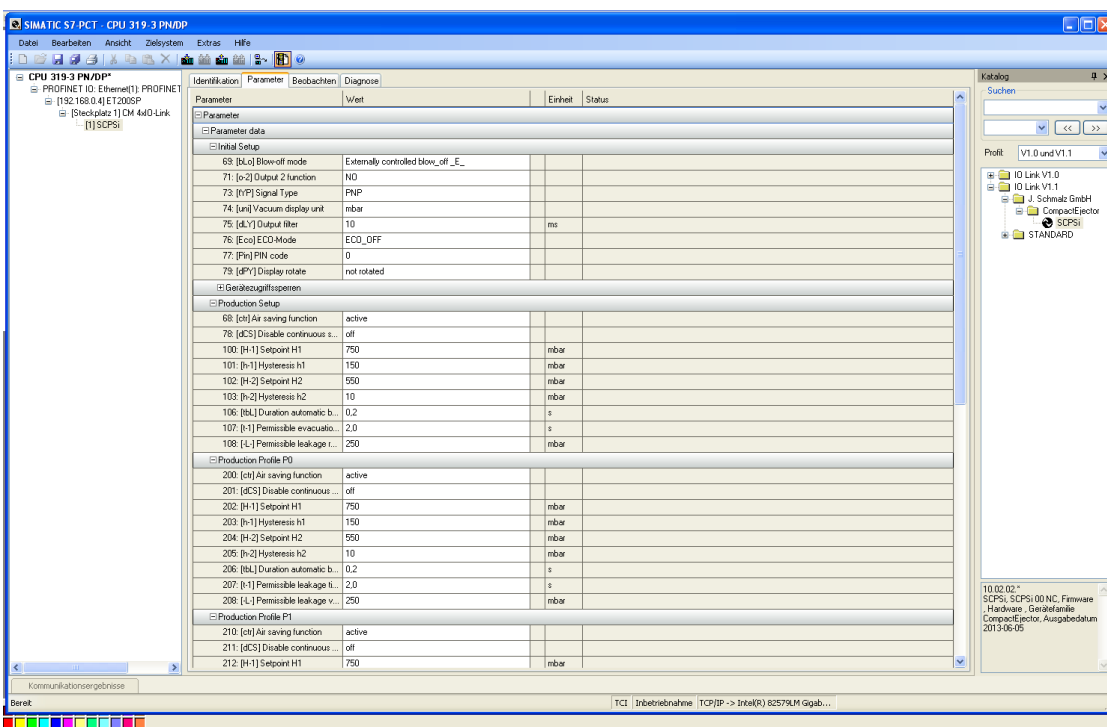
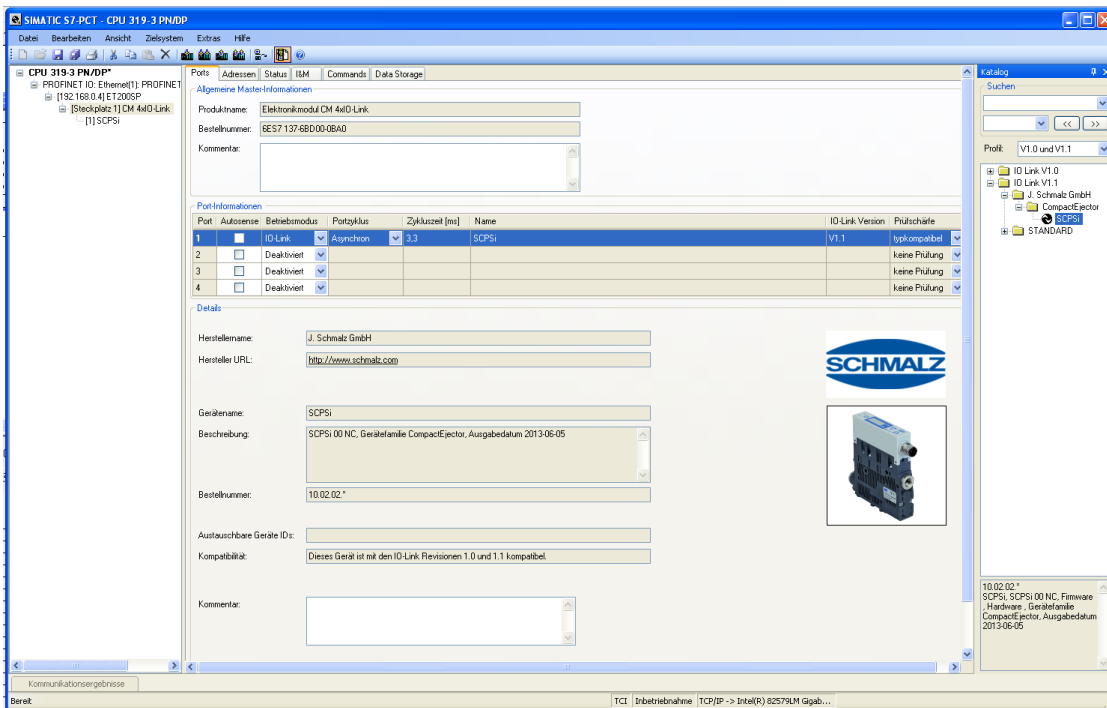

PROCESS DATA

Once communication with an IO-Link master has been established, the master begins the automatic cyclic exchange of process data. The master receives new process output data (PDO) from the controller or field bus level and passes this on to the ejector for control. The feedback and measured values from the ejector are collected from the master as process input data (PDI) and forwarded to the system controller.

In the two possible IO-Link revisions 1.1 and 1.0, the process data from the ejector SCPSi is as follows:

PROCESS DATA INPUT (PDI)

| PDI Byte | Bit | Parameter | IO-Link Revision | |
|----------|-------|--------------------------------------|------------------|-----|
| | | | 1.1 | 1.0 |
| 0 | 0 | Part present (H2) | X | X |
| | 1 | Air saving function (H1) | | |
| | 3 | CM-Autoset-Acknowledge | | |
| | 4 | EPC-Select-Acknowledge | | |
| | 5 | Device status - green | | |
| | 6 | Device status - yellow | | |
| | 7 | Device status - red | | |
| 1 | 7...0 | EPC-Word (multi purpose) | X | - |
| 2 | 7...0 | EPC-Word (multi purpose)...high-byte | X | - |
| 3 | 7...0 | EPC-Word (multi purpose)...low-byte | X | - |

PROCESS DATA OUTPUT (PDO)

| PDO Byte | Bit | Parameter | IO-Link Revision | | |
|----------|-------|---|------------------|-----|---|
| | | | 1.1 | 1.0 | |
| 0 | 0 | Vacuum on/off | X | X | |
| | 1 | Activate Blow-off | | | |
| | 2 | Setting mode | | | |
| | 3 | CM Autoset | | | |
| | 5...4 | EPC-Word-function-select | | | - |
| | 7...6 | Select Production-Setup-Profile P0-P3 (see parameters 200-238) | | | X |
| 1 | 7...0 | System pressure (value from external sensor) (0= feature not used) | X | - | |

PARAMETER DATA

In addition to the process data that is exchanged automatically, the IO-Link protocol provides an acyclical data channel for identification data, setting parameters or general feedback from the device. The available data objects are known as ISDU with IO-Link and are uniquely addressed within a device by their index and subindex.

Controller manufacturers usually provide a specialized function module – e.g. the “IOL_CALL” module for Siemens controllers – to enable these parameters to be accessed from a control program.

See the separate document, “SCPSi Data Dictionary”, to find out which parameter data is offered by the ejector SCPSi and how this data is represented as ISDU objects. This document is available to download from www.schmalz.com.

CONFIGURATION SERVER

Since revision 1.1, the IO-Link protocol has contained an automated process for transferring data when a device is replaced. During this data storage mechanism, the IO-Link master mirrors all setting parameters for the device in a separate non-volatile memory. When a device is swapped for a new one of the same type, the setting parameters for the old device are automatically saved in the new device by the master.

In order for this to work with the ejector SCPSi, it must be operated on a master with IO-Link revision 1.1 or higher and the data storage feature must be activated in the configuration of the IO-Link port.

A detailed description of the data storage mechanism cannot be provided here, however, note the following practical information:













- The device parameters are automatically mirrored in the master when the device is configured using an IO-Link configuration tool such as S7-PCT.
- Changes to the parameters made in the user menu on the device are automatically mirrored in the master.
- Changes to the parameters made by a control program using a function module are not automatically mirrored in the master. In this case, mirroring can be triggered manually by executing ISDU write access to the “System Command” parameter with the “ParamDownloadStore” command (numerical value 5) once all the required parameters have been changed.
- To ensure that data is transferred in the correct direction when a device is replaced, it must be ensured that the new device is restored to the factory settings before it is connected to the IO-Link master. This can be done at any time using the function for restoring the factory settings, for example, via the operating menu.

START OF OPERATIONS

The communication LED on the IO-Link master port indicates the IO-Link communication has been successfully established.

Pressing the  button displays the operating mode of the ejector.

A typical handling cycle is divided into three steps: pick-up, blow-off and the idle state. During the pick-up step, the switching threshold H2 is monitored to determine whether a sufficient vacuum has been established.

| Step | SCPSi – xx – NO – xx | | | SCPSi – xx – NC – xx | | |
|------|---|---------|------------------|---|---------|------------------|
| | Bit | State | Signal | Signal | State | |
| 1 |  | PDO 0.0 | Suction ON |  | PDO 0.0 | Suction ON |
| 2 |  | PDI 0.0 | Vacuum > H2 |  | PDI 0.0 | Vacuum > H2 |
| 3 |  | PDO 0.0 | Suction OFF |  | PDO 0.0 | Suction OFF |
| 4 |  | PDO 0.1 | Blow-off ON |  | PDO 0.1 | Blow-off ON |
| 5 |  | PDO 0.1 | Blow-off OFF |  | PDO 0.1 | Blow-off OFF |
| 6 |  | PDI 0.0 | Vacuum < (H2-h2) |  | PDI 0.0 | Vacuum < (H2-h2) |

 Signal status switches from LOW to HIGH |  Signal status switches from HIGH to LOW

PDO 0.0 = BDO Byte 0 Bit 0

CONDITION MONITORING [CM]

Any condition monitoring events that occur during the suction cycle cause the system status light to immediately switch from green to yellow. The specific event that caused this switch can be seen in the “Condition Monitoring” IO-Link parameter. The following table shows its coding:

| Coding of the condition monitoring warnings | |
|---|--|
| Bit | Event |
| 0 | Valve protection function active |
| 1 | Set limit for evacuation time (t-1) exceeded |
| 2 | Set limit for leakage (-L-) exceeded |
| 3 | Threshold value H1 not reached |
| 4 | Dynamic pressure > (H2-h2) and < H1 |
| 5 | Supply voltage outside the operating range |
| 7 | System pressure outside of working range |

The four bits with the lowest values describe events that can only occur once per suction cycle. They are reset at the start of every suction cycle and remain stable until after suctioning has finished.

Bit number 4, which describes excessive dynamic pressure, is initially deleted when the device is switched on and is only updated when a dynamic pressure value is detected again.

Bits 5 and 7 are permanently updated independently of the suction cycle and reflect the current values for the supply voltage and system pressure.

The measurement values for condition monitoring – the evacuation times t_0 and t_1 as well as the leakage area – are reset at the start of every suction cycle and updated at the point in time when they can be measured.

ENERGY MONITORING [EM]

The measurement value for the absolute air consumption (Air consumption per cycle) is reset at the start of every suction cycle and then permanently updated during the cycle. It can continue to change until after the end of blow-off.

To determine the other EM values – air consumption in percent and electrical energy consumption – the neutral phase of the suction cycle must also be taken into consideration. Therefore, the measurement values can only be updated once the next suction cycle starts and thus show the result of the previous cycle during the complete cycle.

PREDICTIVE MAINTENANCE [PM]

The measurement value for the leakage rate and the related quality assessment in percent are reset at the start of every suction cycle and permanently updated during the cycle as moving averages. The values therefore remain stable until after the suction cycle is complete.

The dynamic pressure (vacuum during unobstructed intake) and the related performance assessment in percent are initially unknown when the ejector is switched on. As soon as a dynamic pressure measurement can be performed, they are updated and retain their values until the next dynamic pressure measurement.

TYPICAL SUCTION CYCLES

The following diagrams show some typical vacuum curves during a suction cycle and show the points at which EPC values could be updated.

Handling cycle with dynamic pressure measurement and average leakage

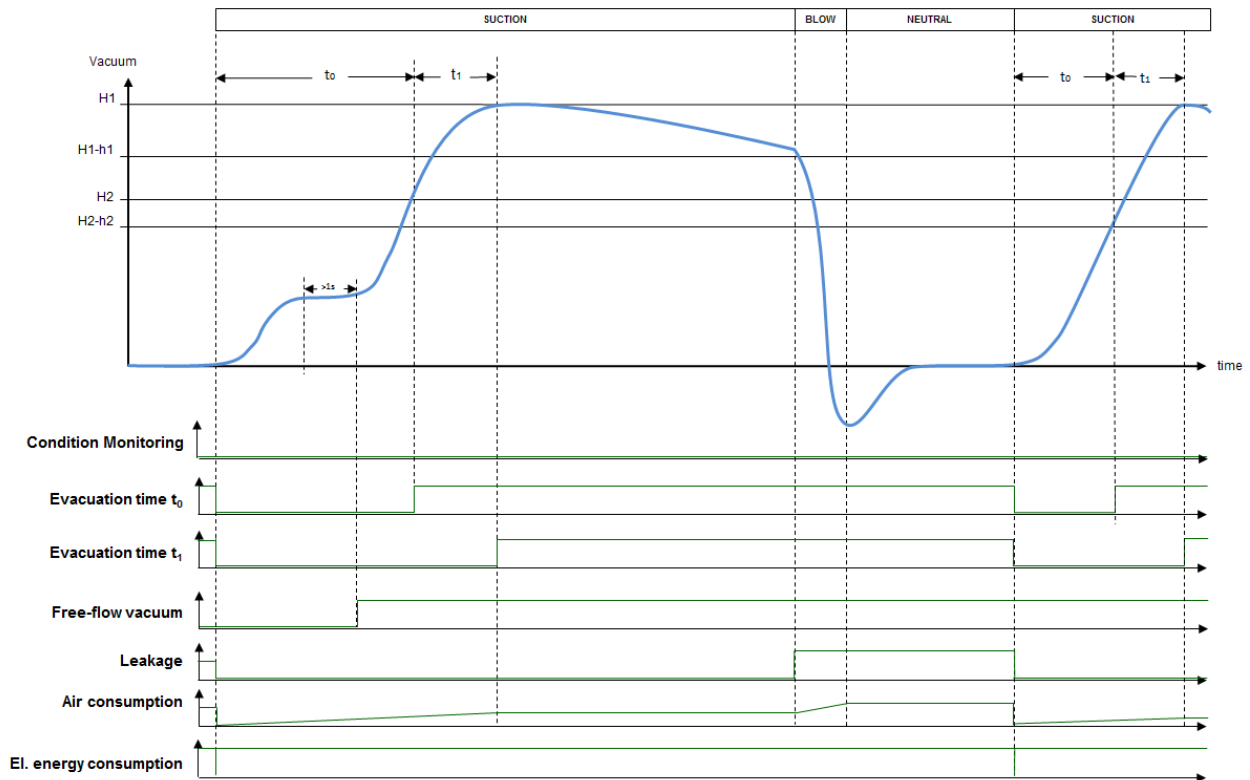

Handling cycle with dynamic pressure measurement and excessive leakage

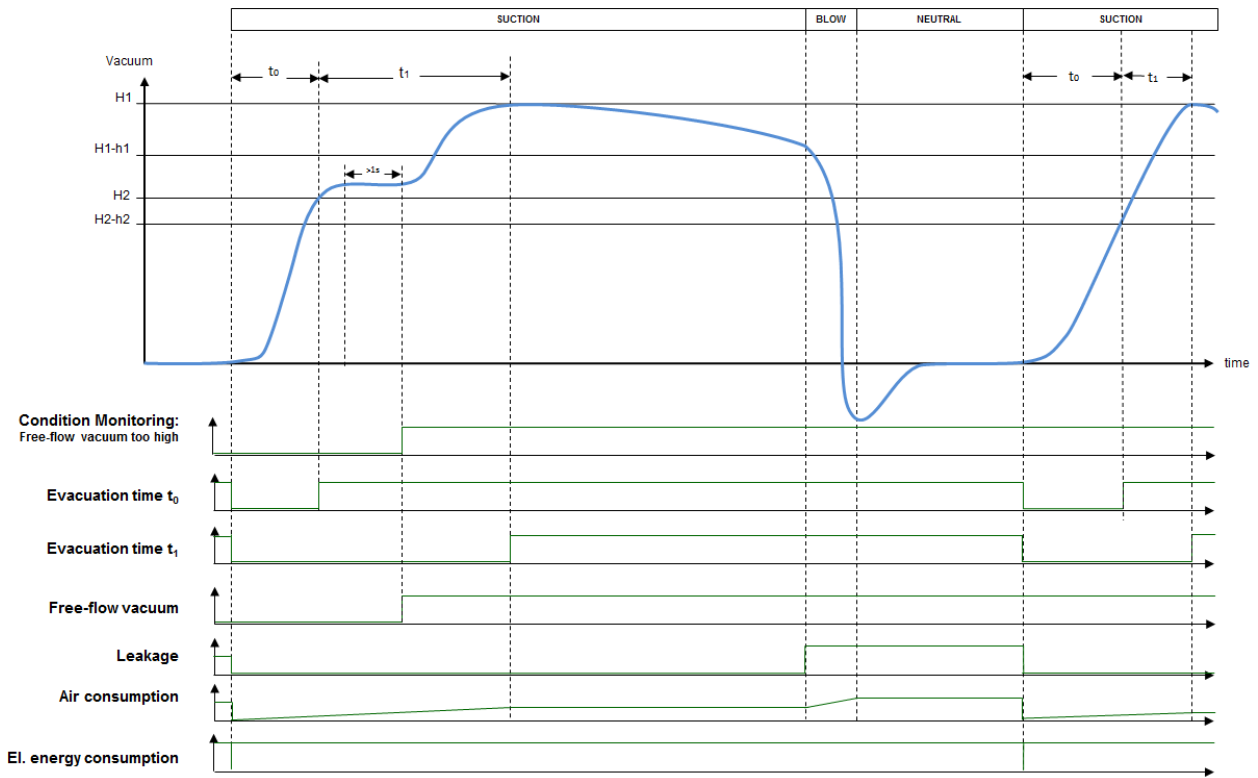

Handling cycle with leakage > L and readjustment

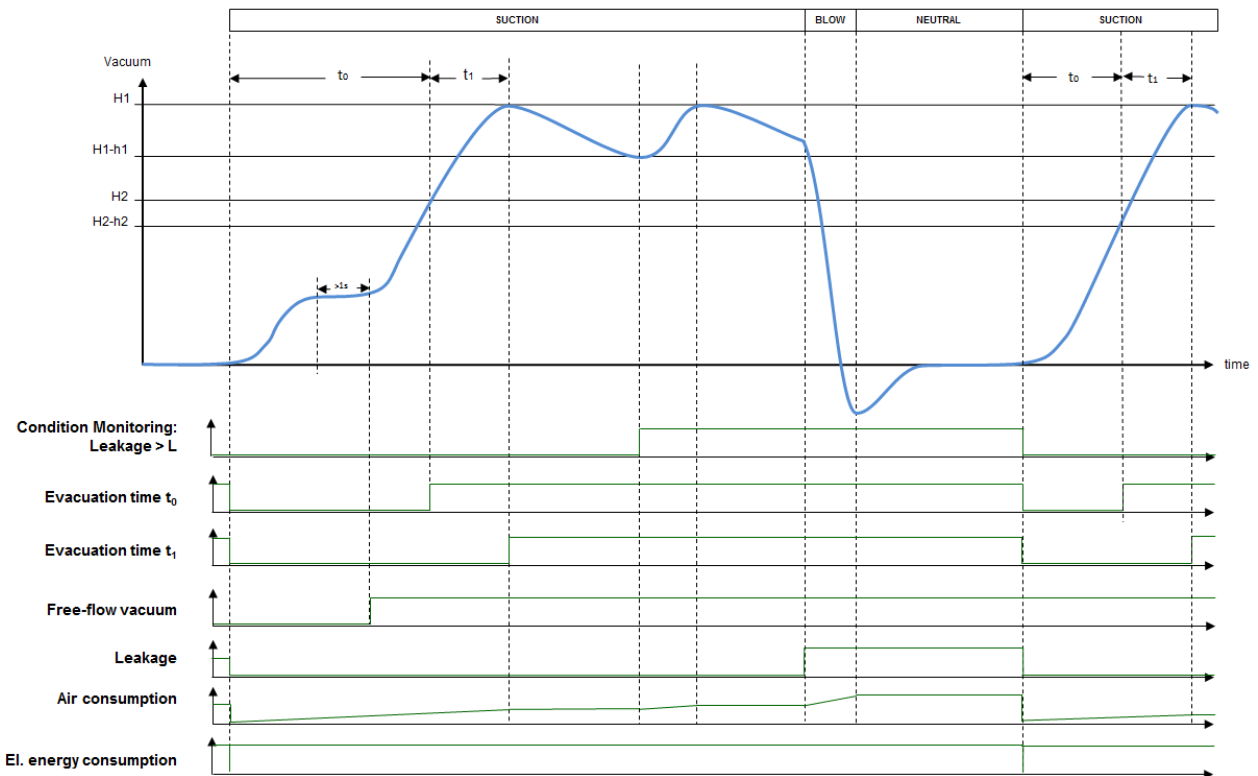

Handling cycle with very high leakage (H1 is not reached)

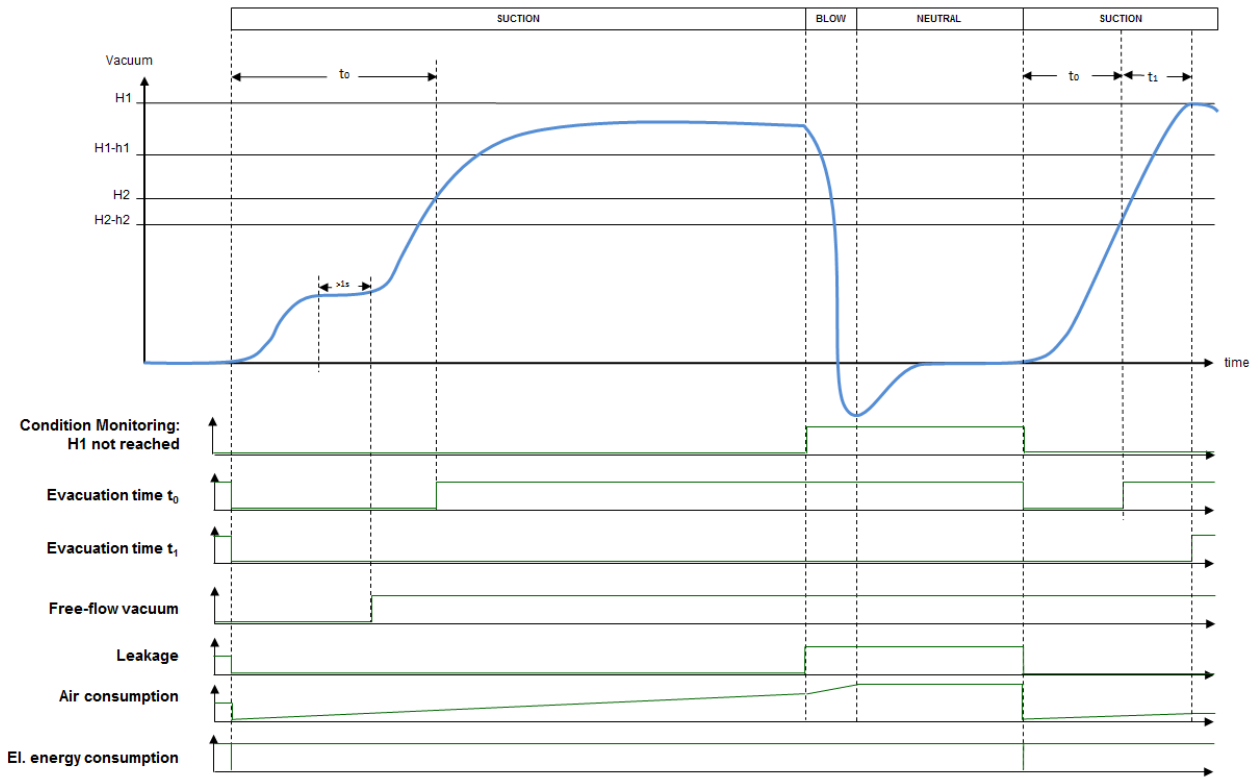

Handling cycle with excessive evacuation time t_1

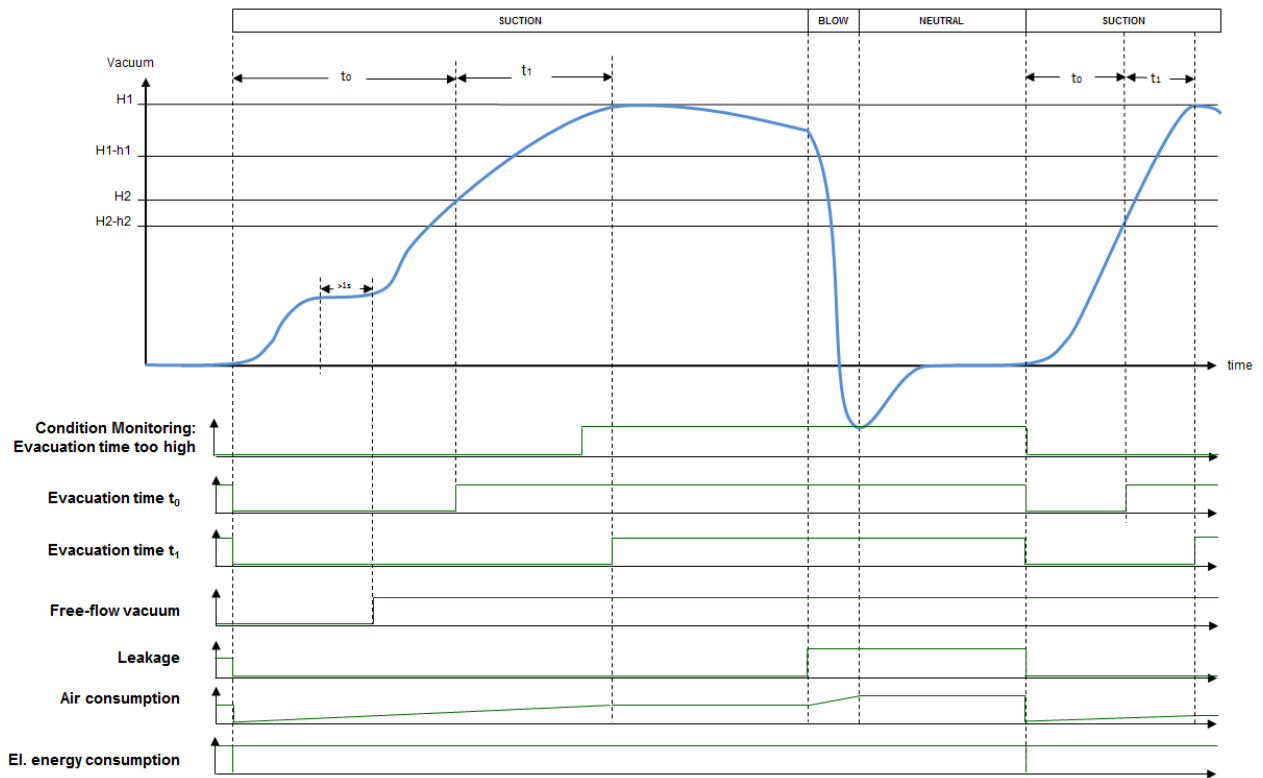

SYSTEM STATUS LIGHT

The overall status of the ejector system is displayed as a traffic light using 3 bits of process data input byte 0. All warnings and errors are used to determine the status shown here.

This basic display provides immediate information about the status of the ejector with all its input and output parameters.

| System status displayed | Overall ejector system status |
|-------------------------|---|
| Green system status | System is working perfectly with optimal operating parameters |
| Yellow system status | Warning – The ejector system is not working optimally; please check the operating parameters (Condition monitoring warnings have occurred) |
| Red system status | Error – Safe operation of the ejector within the operating limits is no longer ensured (Error code is available in the error parameter) |

WARNINGS AND ERRORS

| Coding of the condition monitoring warnings | |
|---|--|
| Bit | Event |
| 0 | Valve protection function active |
| 1 | Set limit for evacuation time (t-1) exceeded |
| 2 | Set limit for leakage (-L-) exceeded |
| 3 | Threshold value H1 not reached |
| 4 | Dynamic pressure > (H2-h2) and < H1 |
| 5 | Supply voltage outside the operating range |
| 7 | System pressure outside of working range |

| Code | Description |
|------|---|
| E01 | Electronics error – internal data management |
| E02 | Electronics error – internal communication |
| E03 | Zero-point adjustment for vacuum sensor outside $\pm 3\%$ FS |
| E07 | Supply voltage is too low |
| E08 | IO-Link communication error |
| E17 | Supply voltage is too high |
| E18 | Operating pressure is too high or too low (with externally supplied pressure value) |

EPC-VALUES IN THE PROCESS DATA

To quickly and conveniently capture the most important results from the condition monitoring [CM], energy monitoring and predictive maintenance functions, these are also made available via the process input data of the device. The top 3 bytes of the process output data are also configured as a multifunctional data range, consisting of an 8 bit value ("EPC Value 1") and a 16 bit value ("EPC Value 2").

The current content of this data supplied by the ejector can be changed via the process output data using the 2 bits "EPC-Select". The four possible ways in which this data is configured is listed in the following table:

| PDO | PDI | | |
|------------|--|---|------------------------|
| EPC-Select | EPC-Value 1 (8-Bit) | EPC- Value 2 (16-Bit) | EPC-Select-Acknowledge |
| 00 | Current input pressure (Unit 0,1 bar) | Current Vacuum level (Unit 1 mbar) | 0 |
| 01 | Condition Monitoring | Evacuation time t_1 (Unit 1 ms) | 1 |
| 10 | Leakage rate (Unit 1 mbar/s) | Last measured dynamic pressure (Unit 1 mbar) | 1 |
| 11 | Supply voltage (Unit 0,1 V) | Air consumption (Unit 0,1 NL) | 1 |

The switch is made depending on the structure of the automation system with some time delay. However, in order to be able to read the different pairs of values efficiently through a controller program, the bit EPC-Select-Acknowledge is provided in the process input data. The bit always accepts the values shown in the table. In order to read out all EPC values, the procedure illustrated in the following diagram is recommended:

Always start with EPC-Select = 00 and create the selection for the next value pair required, e.g. EPC-Select = 01. Now wait until the bit EPC-Select-Acknowledge changes from 0 to 1. This signifies that the values transmitted match the selection created and they can be accepted by the controller.

Now, switch back to EPC-Select = 00 and wait until the bit EPC-Select-Acknowledge is reset to 0 by the ejector. The process for the next value pair, e.g. EPC-Select = 10, can then be performed in the same way, and so on.

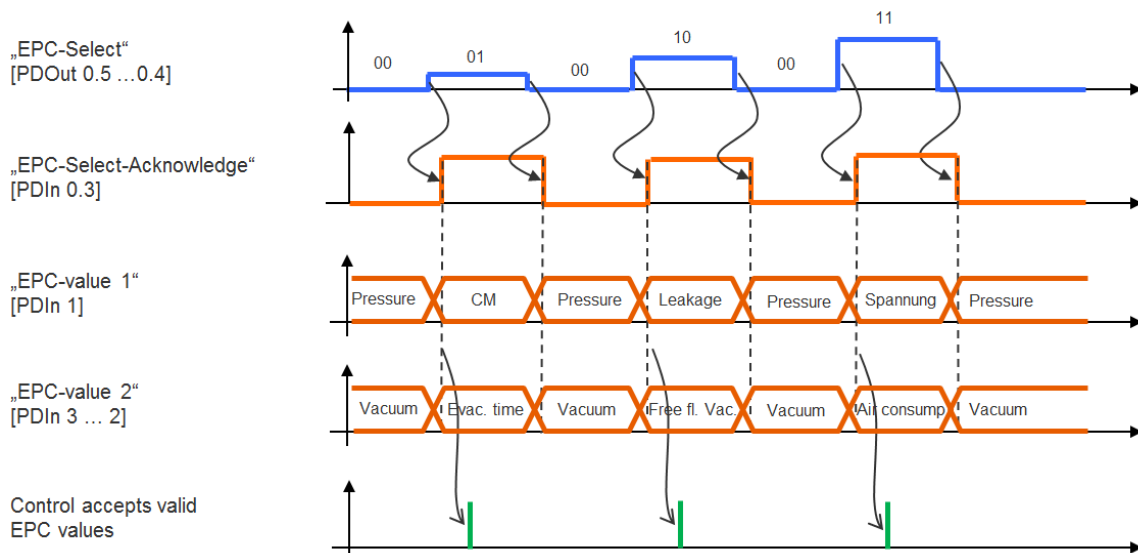

6 MAINTENANCE

GENERAL MAINTENANCE

EXTERIOR SOILING

Remove dirt on the exterior of the device with a soft cloth and soap suds (max. 60°C). Ensure that the silencer and the controller are not soaked with soap suds.

SILENCER

Because it is open, the silencer may be exposed to high levels of dust, oil, etc., which may dirty the silencer to the point of reducing the suction capacity. If this happens, it must be replaced. Cleaning is not recommended due to the capillary effect of the porous material.

PRESS-IN SCREENS

The vacuum and compressed air connections include press-in screens.

Over time, dust, chips and other solids can become deposited in the screens.

If you notice that the performance of the ejector system has declined, simply replace the screens.



Do not operate the ejector system without the screens. This can damage the ejector system.

WARRANTY, SPARE PARTS AND WEARING PARTS

This system is guaranteed in accordance with our general terms of trade and delivery. The same applies to spare parts, provided that these are original parts supplied by us.

We are not liable for any damage resulting from the use of non-original spare parts or accessories.

Wearing parts are not covered by the warranty.

The following list contains the primary spare and wearing parts.

Legend: - Spare part= **S**
 - Wearing part= **W**

SPARE AND WEARING PARTS

| Type | Designation | Article no. | Legend |
|------|-----------------|----------------|--------|
| | Silencer insert | 10.02.02.04141 | W |
| | Screen | 10.02.02.04404 | S |

TROUBLESHOOTING

| Störung | mögliche Ursache | Abhilfe |
|---|---|--|
| Vacuum level is not reach or vacuum is created too slowly | Press-in screen in contami- | Replace the screen |
| | Silencer is dirty | Replace silencer |
| | Leakage in hose line | Check hose connections |
| | Leakage at suction pad | Check suction pad |
| | Operating pressure too low | Increase operating pressure (observe max. limits) |
| | Internal diameter of hose lines too small | See recommended hose diameters |
| Payload cannot be held securely | Vacuum level too low | Increase the control range if the air-saving function is activated |
| | Suction pad too small | Select a larger suction pad |
| Display shows an error code | See "Error codes" table | See "Error codes" table |

ACCESSORIES

| Designation | Article no. |
|---|----------------|
| M12 connection cable, 5-pin, with open end, 5 m | 21.04.05.00080 |
| M12 connection cable, 5-pin, to 5-pin M12 plug, 1 m | 10.02.02.00158 |
| M12 connection distributor, 5-pin, to 2xM12, 4-pin | 10.02.02.03490 |
| Top-hat rail clamp for TS35 top-hat rail, incl. plastic tapping screws (optional) | 10.02.02.04139 |

7 TECHNICAL DATA



Operating the ejector system outside of the specified values can result in damage to the system and attached components.

ELECTRICAL PARAMETERS

| Parameter | Symbol | Limit values | | | Units | Comment |
|--|-----------|--------------|------------------|------------|----------|-----------------------------------|
| | | Min. | Typ. | Max. | | |
| Supply voltage | $U_{S/A}$ | 19,2 | 24 | 26,4 | V_{DC} | PELV ¹⁾ |
| SCPSi – xx – xx – NO – M12 | | | | | | |
| Rated current from $U_{S/A}$ ²⁾ | $I_{S/A}$ | — | 50 ⁴⁾ | 120 | mA | $U_{S/A} = 24,0V$ |
| SCPSi – xx – xx – NC – M12 | | | | | | |
| Rated current from $U_{S/A}$ ²⁾ | $I_{S/A}$ | — | 40 ⁴⁾ | 70 | mA | $U_{S/A} = 24,0V$ |
| Voltage of signal output (PNP) | U_{OH} | $U_{S/SA}-2$ | — | $V_{S/SA}$ | V_{DC} | $I_{OH} < 140 \text{ mA}$ |
| Voltage of signal output (NPN) | U_{OL} | 0 | — | 2 | V_{DC} | $I_{OL} < 140 \text{ mA}$ |
| Current of signal output (PNP) | I_{OH} | — | — | 140 | mA | Short-circuit-proof ³⁾ |
| Current of signal output (NPN) | I_{OL} | — | — | -140 | mA | Short-circuit-proof ³⁾ |
| Voltage of signal input (PNP) | U_{IH} | 15 | — | $U_{A/SA}$ | V_{DC} | Relative to $Gnd_{A/SA}$ |
| Voltage of signal input (NPN) | U_{IL} | 0 | — | 9 | V_{DC} | Relative to $U_{A/SA}$ |
| Current of signal input (PNP) | I_{IH} | — | 5 | — | mA | |
| Current of signal input (NPN) | I_{IL} | — | -5 | — | mA | |
| Reaction time of signal inputs | t_i | — | 3 | — | ms | |
| Reaction time of signal output | t_o | 1 | — | 200 | ms | adjustable |

¹⁾ The power supply must comply with the requirements of EN60204 (protective extra-low voltage).

The power supply, signal inputs and signal outputs are all protected against reverse polarity.

²⁾ Plus the output currents

³⁾ The signal output is protected against short circuits. However, the signal output is not secured against overloading. Constant load currents of $> 0.15 \text{ A}$ can lead to unacceptable heat levels and subsequent destruction of the ejector.

⁴⁾ Average

DISPLAY PARAMETERS

| Parameter | Value | Unit | Comment |
|-------------------------------------|---------|--------|--|
| Display | 3 | Digits | Red 7-segment LED |
| Resolution | ± 2 | mbar | |
| Accuracy | ± 3 | % FS | $T_{amb} = 25\text{ °C}$, based on FS end value (full scale) |
| Linearity error | ± 1 | % | |
| Offset error | ± 2 | mbar | After zero-point adjustment, without vacuum (unit = mbar) |
| Temperature influence | ± 3 | % | $0\text{ °C} < T_{amb} < 50\text{ °C}$ |
| Display refresh rate | 5 | 1/s | This only affects the red 7-segment display (see the "Electrical parameters" section for signal inputs and outputs). |
| Idle time before the menu is exited | 2 | min | If no settings are made in a menu, the ejector automatically returns to display mode. |

MECHANICAL DATA

GENERAL PARAMETERS

| Parameter | Symbol | Limit values | | | Unit | Comment |
|----------------------|---|--------------|-----|------|------|------------------------|
| | | Min. | Typ | Max. | | |
| Ambient temperature | T_{amb} | 0 | — | 50 | °C | |
| Storage temperature | T_{Sto} | -10 | — | 60 | °C | |
| Humidity | H_{rel} | 10 | — | 90 | %r | Free from condensation |
| Degree of protection | | — | — | IP65 | | |
| Operating pressure | P | 2 | 4 | 6 | bar | |
| Operating medium | Air or neutral gas, filtered to 5 μm , oiled or unoled, compressed air w/ quality class 3-3-3 acc. to ISO 8573-1 | | | | | |

MATERIALS USED

| Component | Material |
|--------------------|---|
| Basic body | PA6-GF |
| Inner components | Anodized aluminum, Anodized aluminum alloy, brass, galvanized steel, stainless steel, PU, POM |
| Controller housing | PC-ABS |
| Silencer insert | PE porous |
| Seals | NBR |
| Lubricants | Silicone-free |
| Screws | Galvanized steel |

MECHANICAL PARAMETERS

| Type | Nozzle size | Max. vacuum ² | Suction rate ¹ | Max. blow-off capacity ¹ | Air consumption ¹ | Sound level ¹ | | Weight |
|------------|-------------|--------------------------|---------------------------|-------------------------------------|------------------------------|--------------------------|--------|--------|
| | | | | | | Free sucking | sucked | |
| | mm | mbar | l/min | l/min | l/min | dBA | dBA | kg |
| SCPSi-2-07 | 0,7 | 870 | 32 | 115 | 24 | 63 | 58 | 0,195 |
| SCPSi-2-09 | 0,9 | 870 | 45 | 115 | 40 | 73 | 62 | 0,195 |
| SCPSi-2-14 | 1,4 | 870 | 67 | 115 | 82 | 75 | 70 | 0,195 |

¹⁾ at 4 bar

²⁾ at optimum pressure

DIMENSIONS

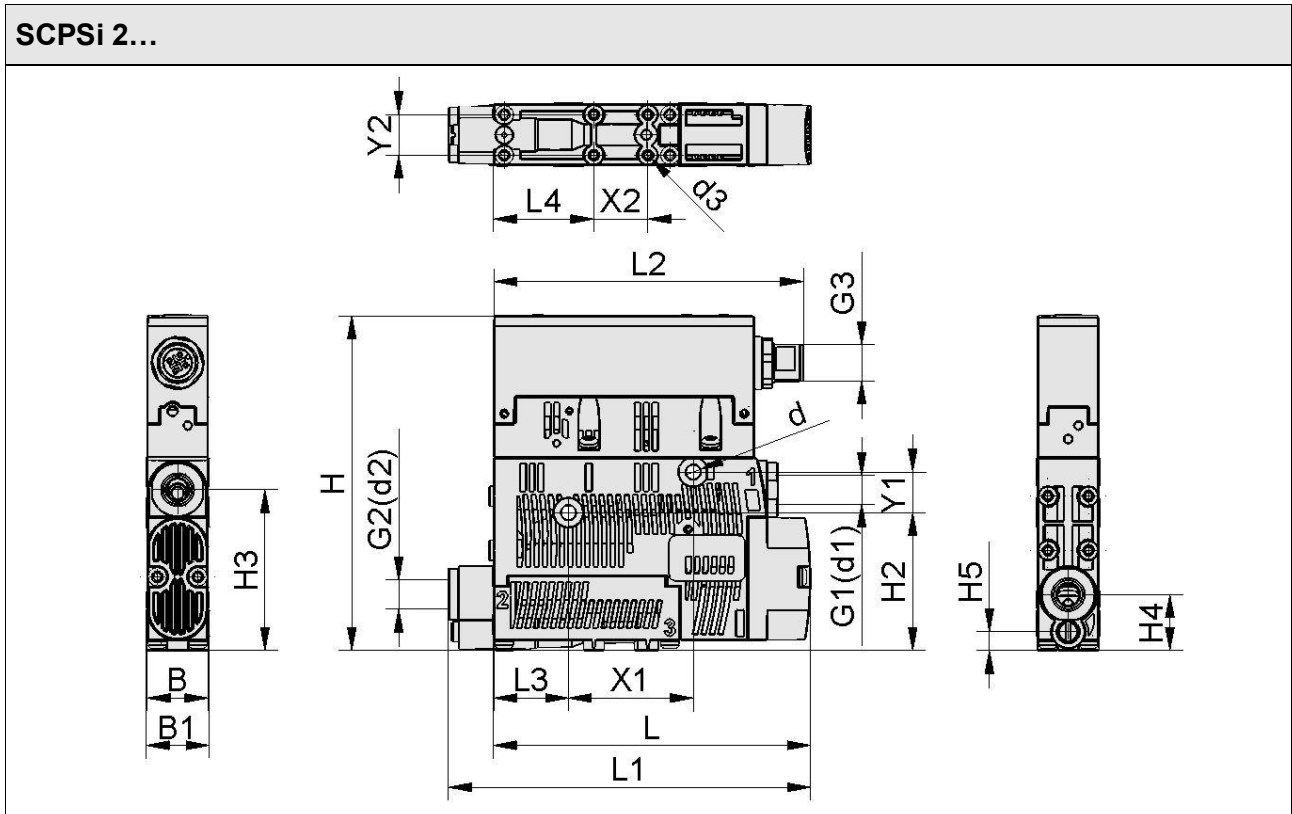

| B | B1 | d | d1 | d2 ¹⁾ | d3 | G1 | G2 | G3 | H | H2 | H3 |
|----|------|-----|----|------------------|-----|----------|----------|----------|----|------|------|
| 18 | 18,6 | 4,4 | 6 | 6 / 8 | 2,6 | G1/8"-IG | G1/8"-IG | M12x1-AG | 99 | 40,8 | 47,5 |

| H4 | H5 | L | L1 | L2 | L3 | L4 | X1 | X2 | Y1 | Y2 |
|------|-----|------|-------|------|----|------|------|----|----|----|
| 16,5 | 5,5 | 93,8 | 107,1 | 91,5 | 22 | 29,5 | 36,9 | 16 | 12 | 12 |

¹⁾ Only with plug-in hose connector





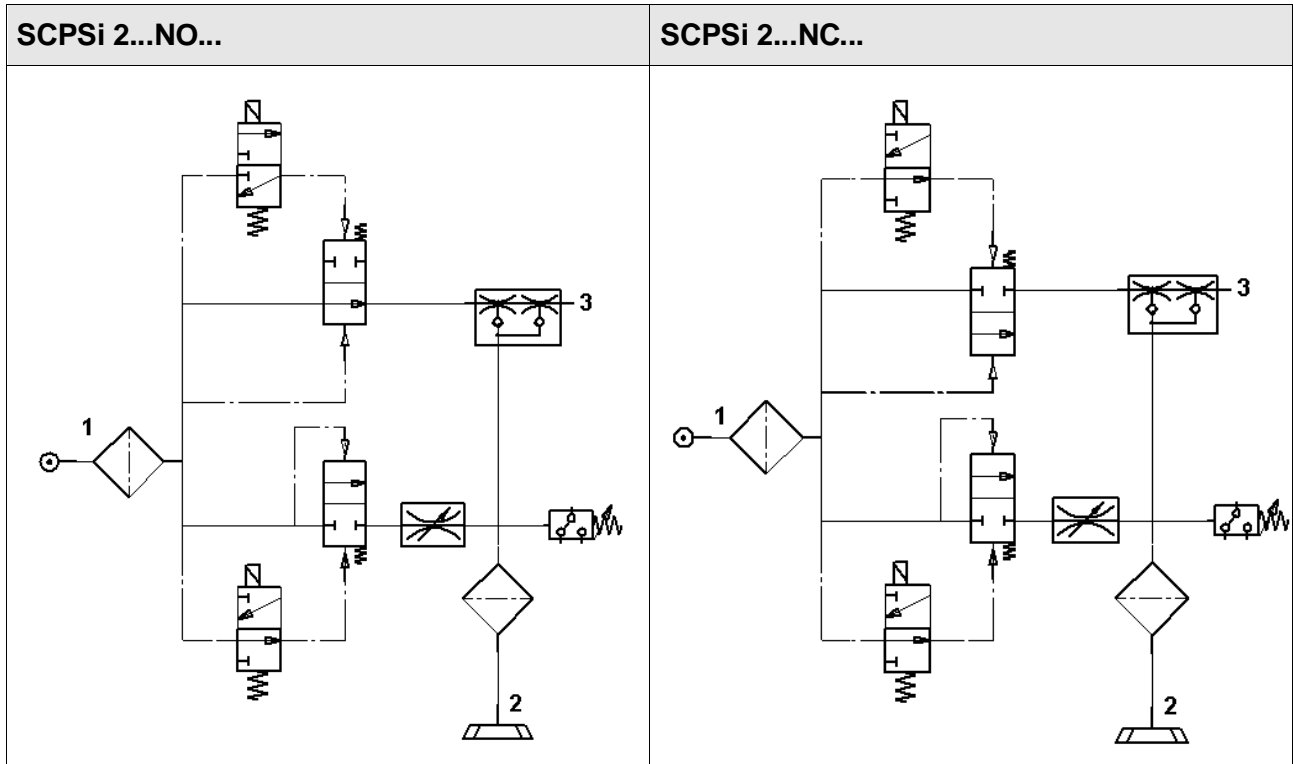





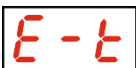
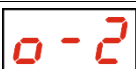







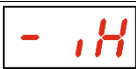

All dimensions in mm

PNEUMATIC CIRCUIT DIAGRAMS



OVERVIEW OF DISPLAY SYMBOLS

| Symbol | Function | Comment |
|--------|--|---|
| H-1 | Switching point H1 | Switch-off value for the air-saving function |
| h-1 | Hysteresis h1 | Hysteresis of the air-saving function |
| H-2 | Switching point H2 | Switch-on value for the “part present control” signal output (when NO output is configured) |
| h-2 | Hysteresis h2 | Hysteresis of “part present control” signal output |
| tBL | Blow-off time | Blow-off time setting for time-controlled blow-off |
| CAL | Zero-point adjustment (calibrate) | Calibrating the vacuum sensor |
| cc1 | Counter 1 | Counter for suction cycles (suction signal input) |
| cc2 | Counter 2 | Counter for valve switching frequency |
| SoC | Software version | Displays the current software version |
| Art | Article number | Displays the article number of the ejector |
| Snr | Serial number | Displays the serial number of the ejector |
| ctr | Air-saving function (control) | Setting for the air-saving function |
| on | Air-saving function on | Activation of the air-saving function |
| onS | Air-saving function on with leakage monitoring | Switching on the air-saving function with leakage monitoring |
| off | Air-saving function off | Deactivation of the air-saving function |
| dcS | Deactivate continuous suction | Enabling continuous suction |
| on | Continuous suction is deactivated | Continuous suction option is deactivated |
| off | Continuous suction is activated | Continuous suction option is activated |
| t-1 | Evacuation time | Setting for the maximum permitted evacuation time |
| -L- | Leakage value | Setting for the maximum permitted leakage |
| blo | Blow-off function | Menu for configuring the blow-off function |
| -E- | “External” blow-off | Selection of externally controlled blow-off (external signal) |

| | | |
|---|---------------------------------------|---|
|  | “Internal” blow-off | Selection of internally controlled blow-off (triggered internally; time can be set) |
|  | “Externally time-controlled” blow-off | Selection of externally controlled blow-off (triggered externally; time can be set) |
|  | Configuration of the signal output | Menu for configuring the signal output |
|  | Normally open contact | Setting the signal output as a normally open contact |
|  | Normally closed contact | Setting the signal output as a normally closed contact |
|  | Configuration of signal type | Menu for configuring the signal type (NPN/PNP) |
|  | PNP signal type | All input and output signals switch according to PNP (input/output on = 24 V) |
|  | NPN signal type | All input and output signals switch according to NPN (input/output on = 0 V) |
|  | Vacuum unit | Vacuum unit in which the measurement and setting values are displayed |
|  | Vacuum value in mbar | The vacuum and pressure values are displayed in mbar. |
|  | Vacuum value (in kPa) | The vacuum and pressure values are displayed in kPa. |
|  | Vacuum value in inHg | The vacuum and pressure values are displayed in inHg. |
|  | Switch-off delay | Setting for the switch-off delay for OUT1 and OUT2 |
|  | Display rotation | Setting the display position (rotation) |
|  | Default display | Display is not rotated |
|  | Rotated display | Display is rotated by 180° |
|  | ECO mode | Configuring ECO mode |
|  | ECO mode on | ECO mode is activated – the display switches off |
|  | Not in ECO mode | ECO mode is deactivated – the display remains on |
|  | PIN | Enter the PIN to unlock the menu |
|  | Menu locked | A lock prevents parameters from being changed. |
|  | Menu unlocked | The buttons and menus are unlocked. |
|  | Reset | All values that can be changed are reset to the factory settings. |

FACTORY SETTINGS

| Symbol | Function | Factory setting |
|--------|------------------------------------|------------------------------------|
| H-1 | Switching point H1 | 750 mbar |
| h-1 | Hysteresis h1 | 150 mbar |
| H-2 | Switching point H2 | 550 mbar |
| h-2 | Hysteresis h2 | 10 mbar |
| tBL | Blow-off time | 0,20 s |
| ctr | Air-saving function | on |
| dcS | Deactivate continuous suction | off |
| t-1 | Evacuation time | 2 s |
| -L- | Leakage value | 250 mbar/s |
| blo | Blow-off function | -E- Externally controlled blow-off |
| o-2 | Configuration of the signal output | no Normally open contact) |
| typ | Signal type | PNP PNP switching |
| uni | Vacuum unit | -bA Vacuum unit (in mbar) |
| dly | Switch-off delay | 10 ms |
| dpy | Display rotation | Std |
| Eco | ECO mode | oFF |
| Pin | PIN-Code | 000 |



The production setup profiles P-1 to P-3 are factory-set to have the exact same data set as the default data set P-0.

8 CONFORMITY DECLARATION

DE EU-Konformitätserklärung
 EN EC- Declaration of Conformity
 FR Déclaration de conformité CE
 ES Declaración de conformidad CE
 IT Dichiarazione di conformità CE
 NL CE Conformiteitsverklaring



Hersteller / Manufacturer / Fabricant / Fabricante / Produttore / Fabrikant

J. Schmalz GmbH, Aacher-Str. 29, D - 72293 Glatten

Produktbezeichnung / Product name / Designation du produit /
 Denominación del producto / Denominazione del prodotto / Beschrijving van de machine

Ejektoren der Serie / Ejectors series / Ejecteurs de la série / Eyectores de la serie / Eiettori de la serie / Ejector Serie **SCPS SCPSi**

Erfüllte einschlägige EG-Richtlinien / Applicable EC directives met / Directives CE applicables respectées /
 Directivas vigentes de la CE cumplidas / Direttive CE applicate ed osservate / Nagekomen betreffende EG-richtlijnen

- 2006/42/EG Maschinenrichtlinie / Machinery Directive / Directive sur les machines /
 Directiva para máquinas / Direttiva macchine / Machinerichtlijn
- 2014/30/EU Elektromagnetische Verträglichkeit / Electromagnetic Compatibility / Compatibilité électromagnétique /
 Compatibilidad electromagnética / Compatibilità elettromagnetica / Elektromagnetische compatibiliteit

Angewendete harmonisierte Normen / Harmonised standards applied / Normes d'harmonisation appliquées /
 Normas armonizadas aplicadas / Norme armonizzate adottate / Toegepaste geharmoniseerde normen

- EN ISO 12100 Sicherheit von Maschinen - Allgemeine Gestaltungsleitsätze - Risikobeurteilung und Risikominderung / Safety of Machinery -
 General principles for design - Risk assessment and risk reduction / Sécurité des machines - Principes généraux de conception -
 Appréciation du risque et réduction du risque / Seguridad de máquinas - Principios generales de diseño - Evaluación del riesgo y
 reducción del riesgo / Sicurezza delle macchine - Principi generali di progettazione - Valutazione del rischio e riduzione del rischio
 / Veiligheid van machines - Algemene beginselen voor ontwerp - Risicobeoordeling en de risicoreductie
- EN 61000-6-3 Elektromagnetische Verträglichkeit - Störaussendung / Electromagnetic Compatibility - Emission /
 Compatibilité électromagnétique - Norme sur l'émission / Compatibilidad electromagnética - Emisión de interferencias /
 Compatibilità elettromagnetica - Norma generica sull'emissione / Elektromagnetische compatibiliteit - emissie
- EN 61000-6-2 Elektromagnetische Verträglichkeit - Störfestigkeit / Electromagnetic Compatibility - Immunity /
 Compatibilité électromagnétique - Immunité / Compatibilidad electromagnética - Resistencia a interferencias /
 Compatibilità elettromagnetica - Immunità / Elektromagnetische compatibiliteit - immunititeit

Dokumentationsverantwortlicher / Person responsible for documentation / Responsable de la documentation /
 Responsable de documentación / Responsabile della documentazione / Verantwoordelijk voor de documentatie

Glatten, 13.03.2017 / i.A. Klaus-Dieter Fanta
 Klaus-Dieter Fanta / J. Schmalz GmbH, Aacher-Str. 29, D - 72293 Glatten

Unterschrift, Angaben zum Unterzeichner / Signature, details of signatory / Signature, indications sur le soussigné /
 Firma y datos del firmante / Firma, dati concernenti il firmatario / Handtekening, omschrijving van de ondertekenaar

Glatten, 13.3.2017 / Andre Czarnetzki
 Andre Czarnetzki
 Leiter Geschäftsentwicklung, Vakuum-Automation /
 Head of Business Development, Vacuum Automation



Visit us online:

Schmalz online – www.schmalz.com

These operating instructions were originally written in German and have been translated into English.

We reserve the right to make technical changes. No responsibility is taken for print errors or other types of errors.

All information and specifications are subject to change without notice.

© J. Schmalz GmbH. All rights reserved.



Schmalz worldwide

Canada

Tel.+1 905 569 9520
Fax+1 905 569 8256
schmalz@schmalz.ca

China

Tel.+86 21 5109 9933
Fax+86 21 5039 8882
schmalz@schmalz.net.cn

Finland

Tel.+358 9 85746 92
Fax+358 9 85746 94
schmalz@schmalz.fi

France

Tel.+33 (0) 1 6473 1730
Fax+33 (0) 1 6006 6371
schmalz@schmalz.fr

India

Tel.+91 (0) 20 4072 5500
Fax+91 (0) 20 4072 5588
schmalz@schmalz.co.in

Italy

Tel.+39 0321 621510
Fax+39 0321 621714
schmalz@schmalz.it

Japan

Tel.+81 45 308 9940
Fax+81 45 308 9941
schmalz@schmalz.co.jp

Netherlands

Tel.+31 (0)74 255 5757
Fax+31 (0)74 255 5758
schmalz@schmalz.nl

Poland

Tel.+48 (0)22 46 04970
Fax+48 (0)22 87 40062
schmalz@schmalz.pl

Russia

Tel.+7 495 9671248
Fax+7 495 9671249
schmalz@schmalz.ru

Spain

Tel.+34 94 4805585
Fax+34 94 4807264
schmalz@schmalz.es

South Korea

Tel.+82 31 8162403
Fax+82 31 8162404
schmalz@schmalz.co.kr

Switzerland

Tel.+41 44 88875 25
Fax+41 44 88875 29
schmalz@schmalz.ch

Turkey

Tel.+90 216 3400121
Fax+90 216 3400124
schmalz@schmalz.com.tr

USA

Tel.+1 919 7130880
Fax+1 919 7130883
schmalz@schmalz.us