

EN

Operating Instructions Innospann Adapter Plate

Please note

These operating instructions were prepared in German.
Store for future use.

Subject to technical changes, typographical and other errors.

Publisher

© J. Schmalz GmbH, 12.2018

This document is protected by copyright law. All resulting rights remain the property of J. Schmalz GmbH. The reproduction of the document or parts thereof is only permitted within the legal restrictions established by copyright law. Any amendment or abridgement of the document is prohibited without the express written consent of J. Schmalz GmbH.

Contact

J. Schmalz GmbH
Johannes-Schmalz-Str. 1
D-72293 Glatten

Tel. +49 (0)7443 2403-0
Fax +49 (0)7443 2403-259
schmalz@schmalz.de
www.schmalz.com

You can find contact information on the Schmalz companies and trading partners worldwide at
 www.schmalz.com/vertriebsnetz

Content

Adapter-Plate

1	Safety Information	4
1.1	Classification of the safety information	4
1.2	Warnings.....	5
1.3	Mandatory action signs.....	5
1.4	General safety information	6
1.5	Intended use	7
1.6	Requirements and information relating to the installation, maintenance and operating personnel.....	8
2	Product Description	9
2.1	Components of the Adapter-Plate and the clamping system	9
2.2	General description of the functions	9
3	Technical Data.....	12
4	Delivery, Packaging and Transport.....	13
4.1	Delivery.....	13
4.1.1	Scope of delivery	13
4.1.2	Check integrity	13
4.1.3	Report damage.....	13
4.2	Packaging	13
5	Operation.....	14
6	Troubleshooting.....	15
7	Maintenance	16
7.1	General safety information	16
7.2	Cleaning and care.....	16
8	Spare and Wear Parts	17

1 Safety Information

1.1 Classification of the safety information

Danger

This warning warns of danger that will result in death or serious injuries if it is not avoided.

 DANGER	
	<p>Type and source of the danger</p> <p>Consequences of the danger</p> <p>▶ Removing the danger</p>

Warning

This warning warns of danger that may result in death or serious injuries if it is not avoided.

 WARNING	
	<p>Type and source of the danger</p> <p>Consequences of the danger</p> <p>▶ Removing the danger</p>

Caution

This warning warns of danger that may result in injuries if it is not avoided.

 CAUTION	
	<p>Type and source of the danger</p> <p>Consequences of the danger</p> <p>▶ Removing the danger</p>

Attention

This warning warns of danger that may result in property damage if it is not avoided.

ATTENTION	
	<p>Type and source of the danger</p> <p>Consequences of the danger</p> <p>▶ Removing the danger</p>







General information

This symbol is used if important information on handling the machine/system/unit is provided.

	<p>Note / Information</p>
---	---------------------------





1.2 Warnings

Explanation of the warning signs used in these operating instructions.



Icon	Description	Icon	Description
	General warning		Warning of flying parts
	Warning of hand injuries		Warning of vacuum
	Warning of magnetic field		Warning of risk of crushing



1.3 Mandatory action signs

Explanation of the mandatory action signs used in these operating instructions.

Icon	Description	Icon	Description
	Follow the operating instructions		Wear safety boots
	Wear gloves		Wear eye protection

1.4 General safety information

 WARNING	
 	<p>Risk of injury as a result of non-compliance with the general safety information</p> <p>Leads to personal injury and damage to the system</p> <ul style="list-style-type: none"> ▶ The operating instructions contain important information on handling the Adapter-Plate. Please read these operating instructions carefully and store them for future use. ▶ The operating instructions are aligned to the equipment delivered by Schmalz. Customer modifications to the Adapter-Plate are not taken into account and are fundamentally prohibited for reasons of safety! ▶ The Adapter-Plate may only be connected and commissioned once the operating instructions have been read and understood! ▶ The components must generally be protected against damage of any kind! ▶ The operating instructions must be stored with the machine. Please ensure that all individuals who perform activities on the machine are always able to access the operating instructions. ▶ Instruction manuals within the meaning of the Occupational Health and Safety Act and the Equipment Usage Directive must be provided in addition to the operating instructions (machine control switching function). ▶ In particular, the operator must ensure that additional risks, which arise due to the special operating conditions at the place of operation and the integration of the vacuum clamping system in a machine pursuant to Machinery Directive 2006/42/EC, are determined in a risk analysis (in the sense of § 5 of the Occupational Health and Safety Act).

 WARNING	
 	<p>Risk of injury from vacuum and high volume flow</p> <p>Hair, skin, body parts and items of clothing will be sucked in.</p> <ul style="list-style-type: none"> ▶ Wear close-fitting clothing and safety goggles. ▶ Use a hair net. ▶ Do not look or reach into the suction connection. ▶ Ensure that the suction opening is kept away from body orifices.

! WARNING	
	<p>Magnetic field of the permanent magnets integrated into the clamping device</p> <p>Influence on pacemakers or implanted defibrillators, damage to electrical devices</p> <ul style="list-style-type: none"> ▶ Keep individuals with pacemakers or implanted defibrillators away from the magnetic field ▶ Keep electronic devices away from the magnetic field

! CAUTION	
	<p>Risks of using the vacuum clamping system as part of an integrated system at the operating site</p> <p>Property damage and/or personal injury</p> <ul style="list-style-type: none"> ▶ Prepare a risks analysis for the entire system with regard to the vacuum clamping system.

! CAUTION	
	<p>Heavy falling parts</p> <p>Crushing injury to the foot</p> <ul style="list-style-type: none"> ▶ Wear safety boots (S1)

1.5 Intended use

The Adapter-Plate is used on consoles or suction cup mounts of machining centres (CNC-controlled machines and systems). The console or suction cup mount valves introduce the vacuum to the Adapter-Plate vacuum openings.

A machine or system with corresponding safety installations is required to use the Adapter-Plate.

The Adapter-Plate is equipped with suction cup mounts and other accessories. These are then equipped with Innospann suction cups.

The Innospann suction cups are exclusively intended for vacuum clamping flat workpieces, whereby the contact surface must have a two-dimensional design.

Please ensure that the Innospann vacuum units are used in accordance with the corresponding operating instructions.

Please see the machine manufacturer's operating instructions for further information.

1.6 Requirements and information relating to the installation, maintenance and operating personnel

The Adapter-Plate represents state-of-the-art technology and ensures maximum safety.

However, this level of safety can only be reached in practice if all the necessary measures have been taken. The operator of the Adapter-Plate has a duty of care to plan these measures and control their implementation.

All activities associated with the product require fundamental mechanical and pneumatic knowledge as well as knowledge of the related technical terms.

To ensure operational safety, these activities may only be performed by an appropriate expert, or an individual under the instruction and supervision of an expert.

"An expert is any individual whose technical training, knowledge and experience as well as their knowledge of the applicable provisions allows them to assess the activities assigned to them, identify possible risks and take appropriate safety measures. An expert must comply with the applicable technical regulations."

All individuals who perform activities using the Adapter-Plate must read the operating instructions and provide their signature to confirm that they have understood the operating instructions.

The operating company must introduce internal measures to ensure that

1. the Adapter-Plate and the suction cups are only used as intended.
2. the Adapter-Plate and the suction cups are only operated in a flawless and functional state and that, in particular, the functionality of the safety installations is reviewed on a regular basis.
3. the operating instructions are always complete and available in a legible condition at the machine's operating location.
4. only qualified and authorised personnel operate, maintain and repair the Adapter-Plate.
5. the operating personnel is regularly instructed on all issues of occupational health and safety and environmental protection and that they are familiar with the operating instructions and particularly the relevant safety information.
6. the operating vacuum is only activated once the vacuum clamping system is sealed against the workpiece, as incorrect use may impair the vacuum in the system or result in a complete failure.
7. all safety and warning notices attached to the Adapter-Plate are not removed and remain legible.



Any individual assigned to assemble, commission, operate, maintain and repair the vacuum clamping system in the operating company must have read and understood the operating instructions.

2 Product Description

2.1 Components of the Adapter-Plate and the clamping system

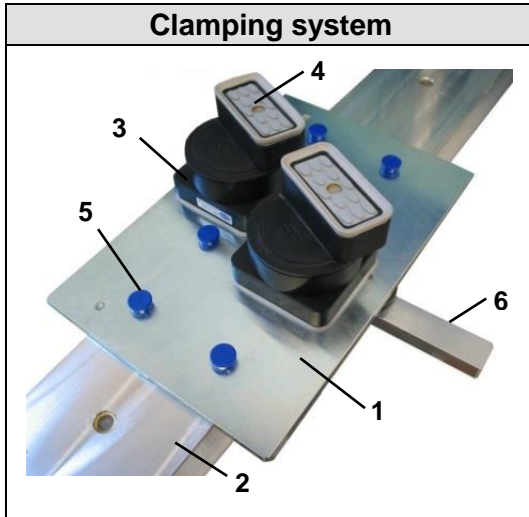

No.	Description
1	Adapter-Plate (ISAP)
2	Console or suction cup mount
3	Mono-Base (ISMB)
4	Suction cup (ISCUP)
5	Magnetic plugs (ISMST)
6	Fixing lever

2.2 General description of the functions

The Adapter-Plate [1] is manufactured from steel. It has vacuum openings in line with its dimensions, which are closed with magnetic plugs [5] on delivery. The Adapter-Plate is positioned and mounted to clean consoles or suction mounts [2].

The vacuum clamping devices [3] and [4] required to clamp the workpiece are placed on the Adapter-Plate over the vacuum openings. These are not included in the Adapter-Plate scope of delivery and must be ordered separately.

Schmalz has special versions of the Adapter-Plate in its range for customised SCM and Biesse* suction mounts.

** SCM and Biesse are registered and protected trademarks. The products listed here were developed specifically for SCM and Biesse machining centres by J. Schmalz GmbH.*

The Schmalz 1-circuit system Adapter-Plate version is fastened using fixing lever [6].

ATTENTION	
	<p>No vacuum available to clamp the workpiece</p> <p>The workpiece is not held in place</p> <ul style="list-style-type: none"> ▶ Check the Adapter-Plate's lever fastening before activating the vacuum! ▶ When positioning the Adapter-Plate, at least one console suction point or suction mount must lie within the Adapter-Plate seal. The seal must not be positioned over a suction point.

The vacuum established (normally -0.7 to -0.9 bar) on the bottom surface clamps the suction cup mount itself as well as the workpiece (via the suction cups) to the clean and level base.

PRODUCT DESCRIPTION

A large selection of suction cups (ISCUP), with various suction area dimensions, are available, as well as an integrated sensing valve (TV) if desired. The suction cups have a sealing frame that limits and seals the actual vacuum surface from the outside area. The suction cups used are endlessly rotatable and use friction-enhancing contact surfaces (support islands and cushions) that yield when vacuum is applied and which create counterpressure on the workpiece surface to be clamped. The pressure also increases friction and makes it more difficult for the workpiece to slip on the suction cup.



The entire clamping unit design, consisting of suction mounts and suction cups, can be enlarged by spacer rings (ISZR-V), which are available in different heights.

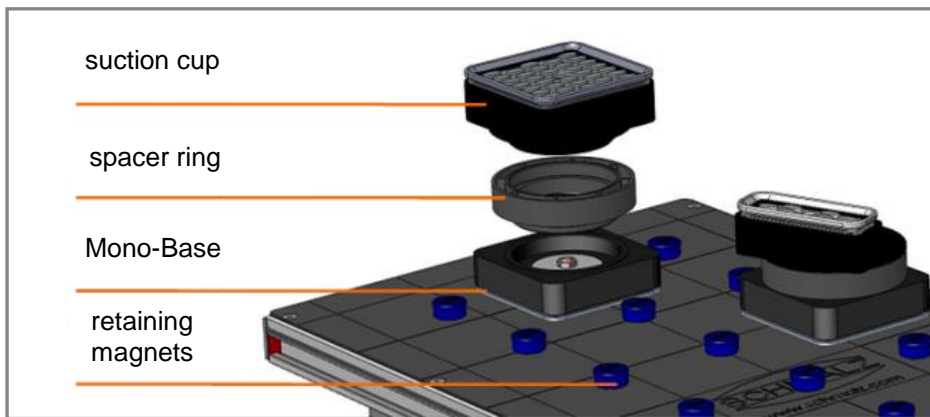

Two varieties of suction cup mounts are available:

- a) Mono-Base (ISMB), see "Mono-Base" figure and
- b) Quad-Base (ISQB), see "Quad-Base" figure

The Mono-Base (ISMB) is used to position one suction cup or one spacer ring.

The Quad-Base (ISQB) is used to position up to four suction cups or spacer rings. Four openings are located at the top of the Quad-Base. These are sealed with four covers on delivery. Suction cups can be fitted in the openings.



Mono-Base (ISMB) on steel plate

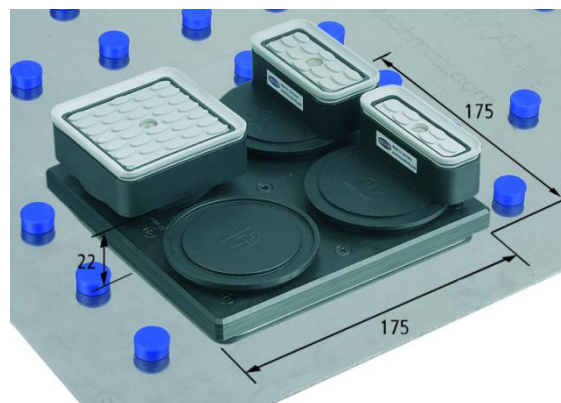



Quad-base (ISQB) on steel plate

The suction cup mounts are fitted with suction cups [4] as per the allocation plan (created using CAD or projection laser). These are placed in the precise position on the Adapter-Plate after removing the relevant magnetic sealing plug(s) [5], whereby the Adapter-Plate is placed on the console or the suction mount.

Please ensure that the Adapter-Plate's vacuum opening is located within the seal of the suction cup mount. When positioning the suction cup mounts, the seal must not be positioned over a suction opening but completely outside of the vacuum opening.

The suction cup mounts and all additional clamping elements are equipped with permanent magnets for pre-fixing.

 WARNING	
	<p>Magnetic field of the permanent magnets integrated into the clamping device Influence on pacemakers or implanted defibrillators, damage to electrical devices</p> <ul style="list-style-type: none"> ▶ Keep individuals with pacemakers or implanted defibrillators away from the magnetic field ▶ Keep electronic devices away from magnetic fields

Products marked with the warning sign displayed here contain permanent magnets.



There is also the option of using vacuum stops, magnetic stops, joint consoles and special clamping units (see the spare and wear parts and order catalogue annex or www.schmalz.de).

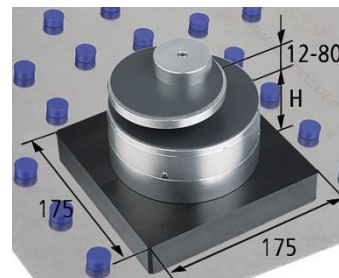
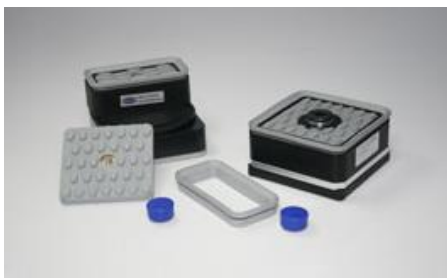

Examples of additional clamping elements and spare parts

3 Technical Data

The following table displays the technical data for the Adapter-Plates:

Vacuum system	Dimensions of the base area [mm]	Height [mm]	Weight [kg]	Mount/ Interface	Item
ISAP-K1	200x300	8	3.6	Schmalz 1-circuit console	10.01.14.00025
ISAP-K1 XXL	600x300	26	10.0	Schmalz 1-circuit console	10.01.14.00876
ISAP-K2	200x200	28	3.0	Schmalz 2-circuit console	10.01.14.00029
ISAP-K2	200x200	26	2.8	Schmalz 2-circuit console	10.01.14.00117
ISAP-K2 XXL	600x300	26	10.0	Schmalz 2-circuit console	10.01.14.01061
ISAP-K2 XXL	600x300	28	10.5	Schmalz 2-circuit console	10.01.14.00897
ISAP-B	195x195	5	1.4	Biesse Mount/Interface	10.01.14.00109
ISAP-S1	195x195	8.7	1.0	SCM S1 mount/interface	10.01.14.00123
ISAP-S2	195x195	4	1.2	SCM S2 mount/interface	10.01.14.00173 10.01.14.00270
ISAP-S3	195x195	4	1.2	SCM S3 mount/interface	10.01.14.00176
ISAP-S4	195x195	11	1.1	SCM S3 mount/interface	10.01.14.00231

4 Delivery, Packaging and Transport

4.1 Delivery

4.1.1 Scope of delivery

The Adapter-Plate set contains the Adapter-Plate, steel plate, the corresponding number of magnetic sealing plugs and operating instructions.

The suction cup mounts (Mono-Base or Quad-Base) and suction cups are not included with the Adapter-Plate and must be ordered separately.

The precise scope of delivery is provided in the order confirmation.



The operating instructions are part of the Adapter-Plate and must be included as part of any change of location.

4.1.2 Check integrity

Check that everything has been included in the shipment based on the enclosed delivery notes.

4.1.3 Report damage

Damage as a result of defective packaging or transport must be reported to the freight forwarder and J. Schmalz GmbH immediately after receipt of the shipment.

4.2 Packaging

The type of packaging depends on the transport route, the dimensions of the product ordered and the weight of the shipment.

Take care when unpacking the shipment.



CAUTION

Knives or other sharp objects may damage seals

Malfunctions and leakage

- ▶ Take care when removing the packaging.



The packaging material must be disposed of in accordance with local laws and directives. Marked transport aids and locks must be removed.

5 Operation

Place the Adapter-Plate on the console or the suction cup mount. Position the required number of suction cup mounts (Mono-Base plus suction cup) over the Adapter-Plate's vacuum openings (first remove the magnetic sealing plugs) and place the workpiece on the suction cups. For the Schmalz 2-circuit version, the Adapter-Plate is attached to the console by turning on the first vacuum circuit.

For the Schmalz 1-circuit system, the Adapter-Plate is attached using a fixing lever [6, figure in section 2.1].

Please note the following when clamping the workpiece:

1. Check the entire clamping system for visible damage and contamination and immediately remove any identified defects.
2. Visually and manually check available clamping surfaces and the secure retention of the workpiece – the workpiece must not be able to shift or be released.
3. The process forces acting on the workpiece are influenced by machine parameters such as the speed of the tool, the feed rate, feed depth (processing depth) and the condition of the respective tool (sharp), and must have the correct values to ensure that the vacuum clamping system's available clamping force is not exceeded.



An operating vacuum of at least -600mbar must be reached at the vacuum suction cup to machine workpieces on the entire machine.

The following activities must be performed before the start of processing:

- Check and ensure that all safety installation have been attached and are functioning.
- Check and ensure that only authorised individuals are located in the machine's or the system's area of operation and that no other individuals are placed at risk by switching on the machine.

The workpiece being machined on the Adapter-Plate or in the system may shift or even be released in the following circumstances:

- Power failure,
- Pump failure and
- Line break.

	CAUTION
	<p>Danger from unexpected malfunctions Personal injury and/or property damage</p> <ul style="list-style-type: none"> ▶ Restart the workpiece clamping process from the very beginning after a failure or disruption of the vacuum supply system. ▶ Restore the vacuum supply and ▶ Check the system for existing software errors (machine control switching functions)

6 Troubleshooting

Fault	Possible cause	Remedy
Insufficient/no vacuum for the clamping device	<ul style="list-style-type: none"> - The vacuum generator is not working - Vacuum not released - Leakage - Adapter-Plate not, or not completely, placed over a vacuum opening in the console. 	<ul style="list-style-type: none"> - Switch on the vacuum generator - Release vacuum "Clamp workpiece" for the clamping device - Check clamping device for leakage - Check clamping device for integrity (of seal) - Check the position of the Adapter-Plate

7 Maintenance

7.1 General safety information



Please read Chapter 1.6 (Requirements and Information relating to the Installation, Maintenance and Operating Personnel) before starting any maintenance work.



WARNING



Risk of accident when maintenance is performed on the system by unqualified personnel

Consequences include serious personnel injury and property damage

- ▶ Only qualified personnel that have read and understood the operating instructions may perform maintenance work on the system.

7.2 Cleaning and care

The console or suction mount and the Adapter-Plate must be cleaned on a regular basis. Clean the suction cup mounts and the suction cups daily (vacuum and wipe with a moist cloth).

Apply lubrication oil to the O-ring area of the suction cups.

Do not use solvents!

8 Spare and Wear Parts

We provide a warranty in line with our General Terms and Conditions of Sale and Delivery for this system. The same applies for spare parts, if this relates to original parts delivered by us.

We assume no liability for damage caused by the use of non-original spare parts and accessories.

The exclusive use of original wear and spare parts is required in order to guarantee the flawless functioning of the vacuum system and to maintain the warranty.

ATTENTION

Use of non-original spare and wear parts

May result in malfunctions or property damage.

- ▶ Only use original parts provided by J. Schmalz as otherwise the warranty expires.

All wear parts are not included in the warranty!

The key spare and wear parts are listed in the following table.

Legend: - **Spare part** = **E**
 - **Wear part** = **V**

Designation	Item no.	Legend
Magnetic sealing plugs, set for Adapter-Plate (4 units)	10.01.14.00847	E

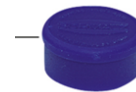

Schmalz Services



Contact worldwide

Our sales network with local sales representatives, international branches and trading partners guarantees quick and competent information and advice in over 50 countries worldwide.

 www.schmalz.com/vertriebsnetz



Documents online

Download catalogues, operating instructions and CAD data conveniently online and familiarise yourself with our products and services.

www.schmalz.com/dokumentationen



"Know how...?" videos

The short videos provide a straightforward and clear explanation of the extensive functions of our products. Take a look, it's worth it!

 www.schmalz.com/gewusst-wie

Additional services, from consulting through to training can be found at

 www.schmalz.com/services